

Construction

Dust Extractors & Air Cleaners & Accessories

Healthy Business

Dustcontrol®



www.dustcontrol.com

Dustcontrol – Technology for Healthy Business

Removing dust from the workplace is not just a working environment and health issue, it is also a business issue. The cleaner the working environment, the better the end result. We call it **Healthy Business**.

What we offer

Dustcontrol manufactures mobile dust extractors for industrial and construction use, fixed extraction systems, peripheral equipment and accessories. We help companies all over the world to achieve a cleaner working environment. Our development department and production facilities are located in Sweden.

Using one of our solutions, you can extract dust, fumes, chips, oil spillages and other harmful substances, right at their source. The result is efficient production. A healthy working environment results in less absence due to illness, more efficient production, less downtime and better production quality.

You will find us in many different types of industries where a clean working environment is necessary. Dustcontrol supplies a complete range of products and accessories for small and large companies alike. For example, we supply advanced cleanroom solutions for the pharmaceutical and electronics industries, mobile dust extractors of various sizes for construction and rental companies and central extraction systems for the automotive and newspaper printing industries.

All of our systems are unique and tailored to each individual company's specific requirements.



Customer Focus

Dustcontrol was founded in 1972, with the idea of manufacturing extraction systems to capture dust and other pollutants at the source. We work closely with our customers, which means that we are always up to date regarding the requirements, regulations and working conditions in different types of workplace. We supply products that meet these ever-changing needs.

But it is not only products that we provide. We also provide the answers to questions such as: How can you capture and extract different kinds of particles and pollutants in the best possible way for your business? How do you deal with waste that can be recycled or reused?



The filter systems in all Dustcontrol mobile dust extractors are built to comply with the the stringent IEC machine classification H.

All our mobile machines are equipped with a fine filter and a HEPA filter (H13) that clean the exhaust air to 99.95 %. These high-efficiency filters also have a long service life, which not only results in cleaner air, but also low filter costs.

With Dustcontrol as your business partner, you will get the answers to these and any other questions that you may have. Whatever the conditions, we develop a source extraction solution that is right for you and your business.

Service & Expertise

Our sales organisation comprises experienced technicians with specialist skills in their areas of expertise. If you need a mobile solution, we will come to your site and show you how it works. In the case of stationary installations, we can design and dimension the entire system to fully match your needs. We can take care of installation, commissioning and documentation, as well as planning a maintenance and service schedule.

We offer a complete service package, including accessories and spare parts. We manufacture and customise portable dust extractors and source extraction systems with very high levels of filtration, in which we use our proprietary filters that have set the industry standard.

As well as being responsible for delivery and installation, our project managers also train the personnel who will be working with our products and systems. In most countries, we have our own team of qualified installers with in-depth knowledge of our products.

With the help of Dustcontrol, you will achieve both a cleaner working environment and a healthy business.

Dustcontrol AB

170 employees.

Founded in 1972.

Head office and factory
in Norsborg, Sweden.

The company is family-owned.

Turnover approx. 28 million Euro.

Subsidiaries in the United Kingdom,
Germany, Austria, USA and Finland.

Distributors in Europe, Asia, Australia
and North & South America.



Our Symbols

1-phase

The dust extractor has a 1-phase power system. Single motor and Twin motor

3-phase

The dust extractor has a 3-phase power system.



The filter systems in all mobile Dustcontrol dust extractors are built to comply with the EN 60335-2-69, Annex AA, H-class.



The product is also available in ESD version.

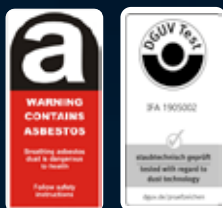

Warning label – Asbestos. This device is H-classified and third party certified by a notified body according to EN 60335-2-69, Annex AA and TRGS 519.

Test Certificate – DGUV Test



We are certified according to ISO14001, ISO 9001 and ISO 45001.



This device is H-classified and third party certified by a notified body according to EN 60335-2-69 Annex AA.

Dustcontrol AB makes every effort to maintain the accuracy and quality of the information provided in this catalogue. However, Dustcontrol AB cannot guarantee and assumes no legal liability or responsibility for the accuracy or completeness of the information provided. The information contained in this catalogue is for general guidance only.

The copyright of all content on this catalogue is owned by Dustcontrol AB. No part of the Dustcontrol AB catalogue may be changed, reproduced, stored in or transmitted on any website or medium without the prior written permission of Dustcontrol AB. Requests to republish any material must be sent to support@dustcontrol.se In case of any questions or remarks, feel free to contact us.

Index

Machines for every Job	6-7
Choose the right machine	8-9
What do the letters mean against our products?	12

1-phase

Dust Extractors – Single motor

DC 1800 & DC 1800 XL	13
DC 2900 a/c/Longopac	14-15
DC 1800 Asbestos	16
DC 2800 Asbestos	17
DC Tromb H 400	20
DC Tromb H Twin	21
DC Tromb 600 Longopac	22
DC Tromb 400 Asbestos	23
DC Chip Extractor	24

3-phase

Dust Extractors

DC Tromb Turbo	29
DC Storm 500/600/700	30-33
DC 5900 9.2 kW S/P	34
DC 5900 Asbestos	35
DC Turbo Tromb Asbestos	35

Compare our Dust Extractors

Semi-Mobile Systems	40-41
Dustcontrol Wet-Vacs	42-43

Dustcontrol Air Cleaners

DC AirCube 500	46
DC AirCube 1200/2000	47

Decontamination Systems

DC Decontamination Box	50-51
------------------------	-------

Dustcontrol Pre-Separators

DCF Tromb & DCF Storm	54
DCF 60 & DCF 2800	55
DCF Cyclone Separator Cover	55
DCF Wheelbarrow	56
DCF Tipping Container	56

Classification of Dust

Extractors & HEPA Filters	58-59
---------------------------	-------

Accessories and Hoses

Cleaning Accessories	61-67
Suction Casings	70-75
Plastic Bags	76-77
Choose the Right Filter	78-79
Filters	80-83

Premium Packaging	84
-------------------	----

Worldwide Distributors	87
------------------------	----

Strategy & Certification	88
--------------------------	----

Check out our QR-codes	89
------------------------	----

Dustcontrol Service	90
---------------------	----

Machines for every job

No matter who you are and what type of work you are involved in, we have exactly the right machines for you and the job that you do. Small and agile or big and powerful? Only you know which Dustcontrol machine is the right one for you.

Floor Finisher

Drilling Specialist

Decontamination and Abatement Specialist



Construction Worker

Carpenter

Painter

Choose the Right Machine

1-phase Single motor Dust extractor

DC 1800. The DC 1800 and DC 1800XL are high-quality, compact versions of our best-selling DC 2900. It combines ease of use with a large suction capacity and high level of filtration.

DC 2900. A small, lightweight dust extractor that can handle tough conditions. Equipped with a cyclone inlet, reverse pulse filter cleaning and separate HEPA filter.

Task or tool

Drilling	Small crosscut and mitre saw, jackhammer
Cleaning Ø38 mm/1.5"	Personal decontamination
Reciprocating saw	Depressed centre disc Ø125 mm/5"
Jig saw	Wall sander Ø125 mm/5"
Abrasive disc Ø125 mm/5"	Oscillating machine
Fibre disc Ø125 mm/5"	

1-phase Twin motor Dust extractor

DC Tromb 400, is a compact, powerful, robust and efficient 1-phase dustextractor. There are three versions within the Tromb family: DC Tromb H 400 dust extractor, DCF Tromb pre-separator and a DC Tromb H 400 Twin dust extractor and pre-separator in one.

DC Tromb 600 is our latest powerful single-phase dust extractor. Launched for the North American market only.

Task or tool

Abrasive disc Ø230 mm/9"	Depressed centr. disc Ø230 mm/9"
Grooving saw 2xØ150 mm/6"	Concrete milling machine
Jackhammer, Circular saw	Chipping hammer
Concrete floor grinding max 500 mm/19"	Cleaning Ø50 mm/2"
	Filler sanding
Max 800 mm/32"	

3-phase Dust extractor

DC Storm 500, 600 and 700

DC Storm is compact, simple to transport and powerful. All these models feature a direct-driven, three-phase turbo pump suitable for continuous operation, heavy material transport, source extraction and cleaning. Equipped with frequency converters are suitable for use when only 16A access is available.

DC Tromb Turbo (Direct start or VFD), are equipped with a powerful three-phase turbo motor which is suitable for heavy cleaning (38 mm/1.5" accessories).

Task or tool

Concrete floor grinding 850 mm/33,5"	Semi-mobile system
Abrasive disc Ø300 mm/12"	Material transport
Suction lance Ø76 mm/3"	Brick saw Ø400 mm/16"
Concrete milling machine	Cleaning Ø50 mm/2"
Depressed centre disc Ø300 mm/12"	

Wet-vac

DC 50W and DC 75W. Sucks up water and slurry in all situations, for example when making holes with a diamond saw. The slurry can be collected in a filter bag. The unit is equipped with a submersible pump for continuous evacuation of the water.

Task or tool

Drilling
Demolition
Water damage



DC 50W

DC 75W

Air cleaner

DC AirCube 500, 1200 and 2000

Air cleaners are used as a complement to source extraction in very dusty environments. Recommended air change is 10 times per hour minimum.

Task or tool

Jackhammering, wall sanding, concrete grinding, demolition work, kitchen and bathroom renovation, and other construction work

Pre-separators

When large quantities of dust are produced, we recommend a pre-separator:



DCF 2800



DCF 60



DC 1800



DC 1800 XL



DC 2900L



DCF Tromb



DC Tromb H 400a



DC Tromb H Twin 400cL



DC Tromb H 600L



DCF Storm



DCF Wheelbarrow



DC Tromb Turbo



DC Storm 600L

Dust Classification H



The filter systems in all Dustcontrol dust extractors are built to comply with the stringent IEC machine classification H.



DC AirCube 500



DC AirCube 1200



DC AirCube 2000





1-Phase Dust Extractors



What do the letters mean against our products?

These letters describe which collection container comes with our machines. For our twin-models we use a combination, CL, AA and CA.

We also use abbreviations for the various performance, usage and material of the machines. We hope this will make your selection easier and quicker.

Collection Containers:

- c Bag
- a Container
- L Longopac bag

Performance, Usage and Material:

- H This device is H-classified and third party certified by a notified body according to EN 60335-2-69 Annex AA.
- P Turbo pump in Parallel drive
- S Turbo pump in Serial drive
- TR Compressed air driven
- EX ATEX
- SS Stainless Steel container/cyclone
- I Industry-line
- LPG Liquid Propane Gas powered
- Turbo Turbo-3-phase motor
- DCF Pre-Separator

Single-Phase Dust Extractors

DC 1800^H

This machine is particularly suitable for general cleaning and source extraction from handheld power tools (with suction casings up to Ø125 mm/5") and small table saws.

The DC 1800 H is equipped with a container. A plastic bag can be used inside the container to facilitate the emptying of dust and other material.

Part No DC 1800 H

101800	230V /50Hz, EU
101801	230V /50Hz Auto start*, EU
101808	230V /50Hz, CH
101810	115V /50Hz, UK
101820	230V /50Hz, UK
101830	115V /60Hz, US/CAN
101809	230V /50Hz, AU

1-phase



Supplied with (Part No)

- Suction hose (Ø38 mm/1.5"), 5 m (2111)
- Suction hose, antistatic (Ø38 mm/1.5"), 5 m/16 ft (2012)
- UK/US/CAN models
- Connecting sleeve (2115)
- Coupling socket (2108)
- Floor nozzle (B370 mm/W17") (7235)
- Suction pipe (Ø38 mm/1.5") (7257)
- Plastic bag (42291)
- Bag support frame (42369)
- Fine filter, cellulose (42029)
- HEPA H13 filter (42027)

Technical data

HxWxD [mm/in]	780x405x390/31x16x15
Weight [kg/lb]	14/31
Hose length Ø38 mm /1.5" [m/ft]	5/16
Collection container [l/gal]	20/5.2
Flow max, fan, EU [m³/h]	205
Flow max, fan, UK 115V/230V [m³/h]	190/205
Flow max, fan, US/CAN 115V [cfm]	126.5
Negative pressure, max, EU/UK [kPa]	24
Negative pressure, max, US/CAN [inwg]	84
Power 115/230V [W]	1340/1285
Sound level [dB(A)]	68

DC 1800^{XL}

The DC 1800 XL is especially suited for parquet grinding and other working operations that produce light dust. Suitable for general cleaning and source extraction from handheld power tools (with up to 5" suction casings) and small table saws. It is slim, lightweight and ideal for those that need a highly portable machine that is powerful enough for source extraction. Equipped with a steel container.

Part No DC 1800 XL

101880	230V /50Hz, EU
101881	230V /50Hz, Auto start*, EU
101884	230V /50Hz, UK
101885	115V /60Hz, USA
101887	115V /60Hz, CAN
101888	230V /50Hz, CH

1-phase



Supplied with (Part No)

- Suction hose antistatic (Ø38 mm 1.5") 5 m (2012+2114)
- Coupling socket 50/38 (2108)
- Fine filter, cellulose (42029)
- HEPA H13 filter (42027)

Technical data

HxWxD [mm/in]	1160x380x380/46x15x15
Weight [kg/lb]	19/42
Hose length Ø38 mm /1.5" [m/ft]	5/16
Collection container [l/gal]	60/15.9
Flow max, fan, EU [m³/h]	205
Flow max, fan, UK 115V/230V [m³/h]	190/205
Flow max, fan, US/CAN 115V [cfm]	126.5
Negative pressure, max, EU/UK [kPa]	24
Negative pressure, max, US/CAN [inwg]	84
Power 115/230V [W]	1340/1285
Sound level [dB(A)]	68

*) DC 1800 Auto start. Plug the handheld power tool into the power socket on the unit. Set the selector switch to the AUTO position. The dust extractor will start automatically when the power tool is started. Power connected tool – min 200 W.

Single-Phase Dust Extractors

With plastic bag

DC 2900

The DC 2900c is our most popular dust extractor. It is suitable for vacuum cleaning and source extraction from handheld power tools (with suction casings up to Ø125 mm/5") and small table saws. The DC 2900c has a sturdy steel chassis with large wheels, but is still light and portable.

Part No DC 2900c

120000	230V /50Hz, EU
120003	230V /50Hz, UK
120008	230V /50Hz, CH
120013	115V /50Hz, UK
120015	115V /60Hz, US/CAN
120100	230V /50Hz, Auto start*, EU
120103	230V /50Hz, Auto start*, UK
120009	230V /50Hz, AU



Supplied with (Part No)

Suction hose (Ø38 mm/1.5"), 5 m/16 ft (2111)
 Suction hose, antistatic (Ø38 mm/1.5"), 5 m/16 ft (2012) UK/US/CAN models
 Connecting sleeve (2115)
 Coupling socket (2108)
 Floor nozzle B370/W17" (7235)
 Suction pipe Ø38 mm/1.5" (7257)
 Plastic bag (42702)
 Fine filter, cellulose (42029)
 HEPA H13 filter (42027)

Technical data

HxWxD [mm/in]	1110x445x570/44x17x22
Weight [kg/lb]	16/35
Hose length Ø38 mm /1.5" [m/ft]	5/16
Collection container [l/gal]	20/5.3
Flow max, fan, EU [m³/h]	205
Flow max, fan, UK 115V/230V [m³/h]	190/205
Flow max, fan, US/CAN 115V [cfm]	126.5
Negative pressure, max, EU/UK [kPa]	24
Negative pressure, max, US/CAN [inwg]	96
Power 115/230V [W]	1284/1285
Sound level [dB(A)]	68

With container

DC 2900^H

Collection in a container makes the DC 2900a H ideal to use for sharp material such as metal chips.

Part No DC 2900a H

121000	230V /50Hz, EU
121003	230V /50Hz, UK
121008	230V /50Hz, CH
121013	115V /50Hz, UK
121015	115V /60Hz, US/CAN
121100	230V /50Hz, Auto start*, EU



Supplied with (Part No)

Suction hose, antistatic (Ø38 mm/1.5"), 5 m/16 ft, (2012)
 Floor nozzle B370 /W17" (7235)
 Suction pipe Ø38 mm/1.5" (7257)
 Fine filter, polyester (42028)
 HEPA H13 filter (42027)

Technical data

HxWxD [mm/in]	1145x445x630/45x17x25
Weight [kg/lb]	22/48
Hose length Ø38 mm /1.5" [m/ft]	5/16
Collection container [l/gal]	40/10.6
Flow max, fan, EU [m³/h]	205
Flow max, fan, UK 115V/230V [m³/h]	190/205
Flow max, fan, US/CAN 115V [cfm]	126.5
Negative pressure, max, EU/UK [kPa]	24
Negative pressure, max, US/CAN [inwg]	96
Power 115/230V [W]	1285/1285
Sound level [dB(A)]	68

*) DC 2900 Auto start. Plug the handheld power tool into the power socket on the unit. Set the selector switch to the AUTO position. The dust extractor will start automatically when the power tool is started. Power connected tool – min 200 W.

With Longopac DC 2900

The DC 2900 is our most popular dust extractor. It is suitable for vacuum cleaning and source extraction from handheld power tools (with suction casings up to Ø125 mm/5") and small table saws.

We are now launching DC 2900L with Longopac output, a flexible bag system, where dust is collected in a closed system. The DC 2900L can be ordered with a plastic bag/Longopac (DC 2900c/DC 2900L) or a container (DC 2900a).

Part No DC 2900L

122000	230V, EU
122003	230V, UK
122008	230V, CH
122013	115V, UK
122015	115V, UL
122100	230V, Auto start*, EU
122108	230V, Auto start*, EU
122009	230V, AU

Supplied with (Part No)

Suction hose (Ø38 mm/1.5"), 5 m/16 ft (2111)
 Suction hose, antistatic (Ø38 mm/1.5"), 5 m/16 ft (2012) UK/US/CAN models
 Connecting sleeve (2114)
 Coupling socket (2108)
 Floor nozzle B370/W17" (7235)
 Suction pipe Ø38 mm/1.5" (7257)
 Longopac mini 12 (44763)
 Fine filter, cellulose (42029)
 HEPA H13 filter (42027)

Accessories (Part No)

Longopac mini 12 (6 pcs á 12 m) (44763)
 Longopac mini 23 (4 pcs á 23 m) (432177)



*) DC 2900 Auto start. Plug the handheld power tool into the power socket on the unit. Set the selector switch to the AUTO position. The dust extractor will start automatically when the power tool is started. Power connected tool – min 200 W.

Technical data

HxWxD [mm/in]	1110x445x570/44x17x22
Weight [kg/lb]	19/42
Hose length Ø38 mm /1.5" [m/ft]	5/16
Collection container [m/ft]	Longopac
Flow max, fan, EU [m³/h]	205
Flow max, fan, UK 115V/230V [m³/h]	190/205
Flow max, fan, US/CAN 115V [cfm]	126.5
Negative pressure, max, EU/UK [kPa]	24
Negative pressure, max, US/CAN [inwg]	96
Power 115V/230V [W]	1340/1285
Sound level [dB(A)]	68



Single-Phase Dust Extractors



DC 1800 H Asbestos

The DC 1800 H Asbestos complies with the most stringent requirements and is IFA* certified. Asbestos is a known cancer causing material that should be removed with caution. This dust extractor is equipped with an antistatic hose, a plug for the cyclone inlet, plastic bags and other safety features.

Don't take risks with your health when removing asbestos!

Supplied with (Part No)

Suction hose antistatic (Ø38 mm /1.5"), 5 m /16 ft (2012)
Coupling socket (2108)
Floor nozzle B370 mm /W17" (7235)
Suction pipe Ø38 mm /1.5" (7257)
10 x plastic bags (42285)
Bag support frame (42369)
Motor cooling filter (432183)
Fine filter, polyester (42028)
HEPA H13 filter (42027)
Inlet plug (42250)

Part No DC 1800H Asbestos

101800-1 230V, EU
101808-1 230V, CH
101810-1 115V, UK

1-phase



*Institute for occupational safety and health of the German Social Accident Insurance.

Technical data

HxWxD [mm/in]	740x380x380/429x15x15
Weight [kg/lb]	14/31
Hose length Ø38 mm /1.5" [m/ft]	5/16
Collection container [l/gal]	20/5.3
Flow max, fan, EU [m³/h]	205
Flow max, fan, UK 115V/230V [m³/h]	205
Flow max, fan, US/CAN 115V [cfm]	126.5
Negative pressure, max, EU/UK [kPa]	21/24
Negative pressure, max, US/CAN [inwg]	84/96
Power 115/230V [W]	1340/1285
Sound level [dB(A)]	68





DC 2800 H Asbestos

The DC 2800 H Asbestos complies with the most stringent requirements and is IFA* certified. Asbestos is a known cancer causing material that should be removed with caution. This dust extractor is equipped with an antistatic hose, a plug for the cyclone inlet, plastic bags and other safety features.

Don't take risks with your health when removing asbestos!

Supplied with (Part No)

- Connecting sleeve (2114)
- Coupling socket (2108)
- Suction hose antistatic (Ø38 mm /1.5") 5 m /16 ft, (2012)
- Floor nozzle B370 mm /W17" (7235)
- Suction pipe (Ø38 mm /1.5") (7257)
- 5 x plastic bags (42285)
- Motor cooling filter (432183)
- Fine filter, polyester (42028)
- HEPA H13 filter (42027)
- Inlet plug (42250)

Part No DC 2800H Asbestos

- 121000-2 230V, EU
- 121013-1 115V, UK
- 121003-1 230V, UK

1-phase



*Institute for occupational safety and health of the German Social Accident Insurance.

Technical data

HxWxD [mm/in]	1110x440x550/43x17x21
Weight [kg/lb]	19/42
Hose length Ø38 mm /1.5" [m/ft]	5/16
Collection container [l/gal]	40/10.6
Flow max, fan, EU [m³/h]	205
Flow max, fan, UK 115V/230V [m³/h]	205
Flow max, fan, US/CAN 115V [cfm]	126.5
Negative pressure, max, EU/UK [kPa]	21/24
Negative pressure, max, US/CAN [inwg]	84/96
Power 115/230V [W]	1340/1285
Sound level [dB(A)]	68





A worker wearing a high-visibility yellow safety jacket with reflective stripes and an orange hard hat is operating a dust extraction system. The worker is positioned on the left side of the frame, leaning over a large, light-colored rectangular panel. A red hose is connected to the system, extending across the floor. The background shows a construction site with various materials and equipment.

1-Phase Dust Extractors

Single-Phase Dust Extractors

DC Tromb H 400

Dustcontrol has taken the DC Tromb H 400 to a new level. There are now three new versions within the Tromb family: DC Tromb H 400 dust extractor, DCF Tromb pre-separator and a DC Tromb Twin dust extractor and pre-separator in one.

As always, we are focusing to meet modern safety requirements along with an ergonomic and modular function. One of the major updates is that the new DC Tromb Twin model is separable. The dust extractor and pre-separator are easily detached and re-assembled from each other making transport simple.

Other important updates include a simpler filter change system and a motor package that is easier to remove. As well as that, improved motors and a sturdier chassis mean that the whole range has gone through a major expansion and upgrade.



Part No DC Tromb H 400

171500	c	230V 3000W, EU
171501	c	115V, UK
171502	c	115V, US
171503	c	2600W 230, UK
171507	c	115V, CAN
171508	c	230V 3000W, CH
171530	L	230V 3000W, EU
171531	L	115V, UK
171532	L	115V, US
171533	L	230V 2600W, UK
171537	L	115V, CAN
171538	L	230V 3000W, CH
172000	a	230V 3000W, EU
172001	a	115V, UK
172002	a	115V US
172003	a	230V /2600W, UK
172008	a	230V /3000W, CH
172500	cc	230V /3000W, EU
172507	cc	TWIN 115V, CAN
172530	cL	TWIN 230V /3000W, EU
172531	cL	TWIN 115V, UK
172532	cL	TWIN 115V, US
172537	cL	TWIN 115V, CAN
172538	cL	TWIN 230V /3000W, CH
172540	aL	TWIN 230V /3000W, EU
172520	aa	TWIN 230V /3000W, EU
172523	aa	TWIN 230V /2600W, UK
172528	aa	TWIN 230V /3000W, CH
172550	LL	TWIN 230V /3000W, EU
172552	LL	TWIN 115V, US
172557	LL	TWIN 115V, CAN
172539	cL	TWIN 230V /3000W, AU
171539-1	L	230V 2600W, AU
171539	L	230V 3000W, AU

1-phase



Supplied with (Part No)

Connecting sleeve (2129)
Coupling socket (2008)
Suction hose antistatic (Ø50 mm /2") 5 m /16 ft (2013)
Suction hose (Ø50 mm /2") 5 m /16 ft (2401) for model 171500 and 171508
Floor nozzle B500 mm /W 19.7" (7238)
Suction pipe (Ø50 mm /2") (7265)
Fine filter, polyester (44017)
HEPA H13 filter (44016)

Discharge

a) 40 l /10.6 US gal container (40070) and 5 x plastic bags (42285)
c) 10 x plastic bags (43619)
L) Longopac 25 m /82 ft (432177)

Technical data

HxWxD [mm/in]	1415x600x780/56x23x31
Weight [kg/lb]	a) 50/110.2 c) 46/101.4 L) 50/110.2
Inlet Ø [mm/in]	76/3
Collection container [l/gal]	a) 40/10.6 c) 20/5.3 L) Longopac
Flow max, fan, EU [m³/h]	420
Flow max, fan, UK 115V/230V [m³/h]	360/420
Flow max, fan, US/CAN 115V [cfm]	212
Negative pressure, max, EU/UK [kPa]	21 (+/- 10%)
Negative pressure, max, US/CAN [inwg]	84
Power 115/230V [W]	2100/2680/3000
Sound level [dB(A)]	70



DC Tromb^H Twin



Accessoires for DC Tromb Twin

With a DCF Tromb Kit you can connect the dust extractor DC Tromb Twin with the pre-separator DCF Tromb.

DCF Tromb Kit L (707010)
 DCF Tromb Kit c (707011)
 DCF Tromb Kit a (707012)

Supplied with (Part No)

Antistatic hose set (Ø50 mm /2") mm x 7,5 m/25 ft
 (Part No 2013+2129+2008)
 Floor nozzle (B500 mm /W 19.7") (7238)
 Suction pipe (Ø50 mm /2") (7265)
 a-model (AA, AL) 5 x plastic bags (42285)
 c-model (CC) with 10 x plastic bags (43619)
 L-model (CL) with Longopac 25 m (432177)
 + 10 x plastic bags (43619)
 Fine filter, polyester (44017)
 HEPA H13 filter (44016)

Technical data

HxWxD [mm/in]	1415x600x1280/56x23x50
Weight [kg/lb]	CC) 71/168 CL) 80/173
Inlet Ø [mm/in]	76/3
Collection container [l/gal]	C) 20/5.3 L) Longopac
Flow max, fan, EU [m³/h]	420
Flow max, fan, UK 115V/230V [m³/h]	360/420
Flow max, fan, US/CAN 115V [cfm]	212
Negative pressure, max, EU/UK [kPa]	21 (+/- 10%)
Negative pressure, max, US/CAN [inwg]	84
Power 115/230V [W]	2100/2680/3000
Sound level [dB(A)]	70

Single-Phase Dust Extractors

DC Tromb 600 L



Supplied with (Part No)

Connecting sleeve (2129)
 Coupling socket (2008)
 Suction hose antistatic (Ø50 mm /2") 5 m/16 ft (2013)
 Floor nozzle B500 mm /W 19.7" (7238)
 Suction pipe (Ø50 mm /2") (7265)
 Fine filter, polyester (44017-1)
 HEPA H13 filter (44016-1)

Technical Data

HxWxD [mm/in]	1600x600x800/63x24x31
Weight [kg/lb]	63/143
Collection container [l/gal]	L) Longopac
Flow max, fan, EU/US [m³/h/cfm]	600/353
Negative pressure, max, EU/US [kPa/inwg]	21 (+/- 10%) / 84
Power 230V/50Hz/60Hz [W]	4050

Part No DC Tromb 600 L 181532 230V /60Hz, US

1-phase



Protected shutter valve

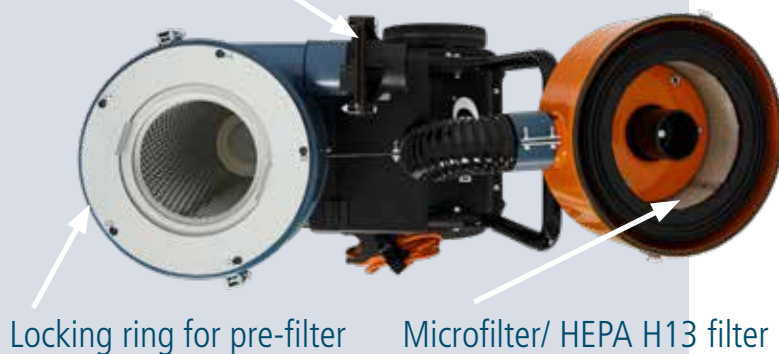

Locking ring for pre-filter

Microfilter/ HEPA H13 filter

The DC Tromb 600 is our most powerful single-phase dust extractor. It is designed to meet modern safety requirements and to work in conjunction with tools that have become ever more efficient and therefore produce more dust than they have previously. The maximum airflow is as high as 600 m³/h = 353 cfm, which is more than enough capacity for equipment such as large floor grinders and large electric cut-off saws.

Not only is the DC Tromb 600 compact, powerful and efficient, but it's versatile too. It is easy to transport around construction sites, move in stair-wells and lift into tight spaces. The wheels are puncture-proof and won't leave marks on the floor. The front wheels are lockable for working on uneven ground. The DC Tromb 600 is adapted for all types of fine dust such as concrete (silica), plaster, wood and filler dust.

The machine comes equipped as standard with a fine filter (rinsable polyester) and an HEPA H13 filter that complies with OSHA regulations. A filter monitor shows the user when it's time to clean the filter. Filter cleaning can be done automatically during operation, or once the work has been completed.



Single-Phase Dust Extractors

DC Tromb 400 H Asbestos

Supplied with (Part No)

- Connecting sleeve (2129)
- Coupling socket (2008)
- Suction hose antistatic (Ø50 mm /2") 5 m/16 ft (2013)
- Floor nozzle B500 mm /W19,7" (7238)
- Suction pipe (Ø50 mm /2") (7265)
- Air filter (44034)
- Fine filter, polyester (44017)
- HEPA H13 filter (44016)
- 5 x plastic bags (42285)
- Plastic bags, 10 pcs, 20 l (43619) (C)
- Longopac Mini Superstrong, 4x23 m (432177) (L)

Technical data DC Tromb 400 H Asbestos A/C/L

HxWxD [mm/in]	1415x560x700/56x22x27
Weight [kg/lb]	50/110
Hose length Ø38 mm /1.5" [m/ft]	5/16
Collection container [m/ft]	40/10.6
Flow max, fan, EU [m³/h]	393
Flow max, fan, UK 115V/230V [m³/h]	393
Flow max, fan, US/CAN 115V [cfm]	231
Negative pressure, max, EU/UK [kPa]	21/24
Negative pressure, max, US/CAN [inwg]	84/96
Power 115V/230V [W]	3000
Sound level [dB(A)]	70

Part No DC Tromb 400 H Asbestos

- 175000 a 230V 3000W, EU
- 175003 a 230V 2600W, UK
- 175008 a 230V 3000W, CH
- 175100 c 230V 3000W, EU
- 175200 L 230V 3000W, EU
- 175000 a 230V 3000W, EU

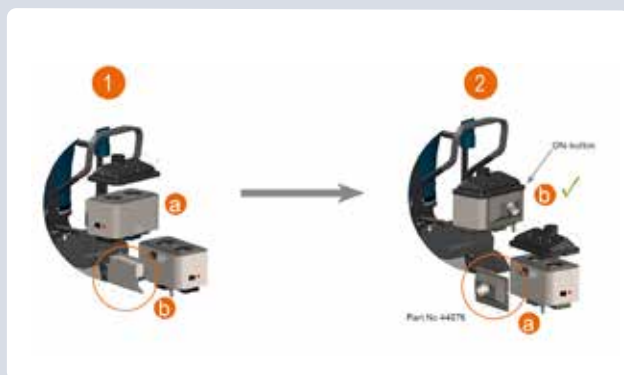

DC Tromb 400 H Asbestos A

DC Tromb 400 H Asbestos C

The DC Tromb 400 H Asbestos is our most powerful 1-phase dust extractor up to now. It is designed to cope with both the demands for a clean and healthy working environment and handheld power tools which are more effective than ever. The dust extractor also enables the user to work without unnecessary interruptions – it tackles up to 400 m³/h. The dust extractor has been DGUV tested and approved by IFA (Institut für Arbeitsschutz der Deutschen Gesetzlichen Unfallversicherung).

The DC Tromb is not just powerful, robust and effective but also versatile and all-round. It can handle all kinds of fine dusts and materials created on a construction site created from cutting concrete, sanding, grinding or drilling floors or walls as well as dust from many other industrial factory processes. The machine can be connected to floor grinders and handheld tools like cutting machines, chisel hammers and saws. Due to its compact design the DC Tromb is also easy to move and transport.

As a standard the machine is equipped with a patented self-cleaning filter (washable polyester) and a H13-filter built to be Application Class H. A signal lamp shows when it's time to clean the filter.*

Accessory

44076 Merged outlet

The DC Tromb 400 H Asbest can be equipped with a new sound absorber, which has one outlet Ø76 mm instead of two. The sound absorber is made of stainless steel. The new outlet will make it easy for the customer to evacuate odour and to minimize air flow in the room.

* Switch operated reverse pulse filter cleaning

Single-Phase Dust Extractors

DC Chip Extractor

The new DC Chip Extractor replaces the previous model DC 3800 Wood Shavings Extractor and is no longer available.

This new machine is based on the DC Tromb chassis and DC Tromb engine package. It is equipped with multiway socket, 3-phase, has updated tighter container and a higher air flow and also larger filter area.

This machine is suitable for general cleaning and source extraction on most saws where continuous operation and a high separation rate are required. It is robust, mobile device that is easy to move. Can be used either as a standard 230 V machine or, as a part of a system with 3-phase cord, with auto start connected to a saw machine.

Part No DC Chip Extractor

174100 230V /50Hz, EU

1-phase



Supplied with (Part No)

Connecting sleeve (2107)
Coupling socket (2129)
Suction hose Ø50 mm/2", 7.5 m/ 22 ft antistatic (2013)
Floor nozzle B 500 mm / W 19.7" (7238)
Suction pipe Ø50 mm/2" (7265)
Plastic bag, 90 l, 1pc (4714)
Fine filter, polyester (44017)
HEPA H13 filter (44016)

Technical data

HxWxD [mm/in]	1530x600x780/60x23.5x31
Weight [kg/lb]	69/152
Hose length Ø50 mm [m/ft]	7.5/25
Collection container [l/gal]	90/24
Flow max, fan, EU [m³/h/CFM]	355/209
Negative pressure, max, EU [kPa/inwg]	22/88
Power 115/230V [W/Hp]	2600/3.5
Sound level [dB(A)]	70







Capture dust with source extraction.

All dust on construction sites is a health hazard in the long term. However, there are some types of dust that are hazardous in the short term too. It has become standard practice for modern construction companies to take the health of their employees seriously and to minimise the levels of dust in the workplace.

Source extraction means that the dust is captured before it spreads and before it can be breathed in. Dust levels can be significantly reduced by fitting all power tools with suction casings and connecting these to efficient dust extractors.

Cleaning should be carried out with a dust extractor with the classification H. The dust extractor should be equipped with a HEPA filter to prevent the spread of the finest dust particles. Sweeping simply stirs the hazardous dust up into the air, subjecting those in the area to further exposure. To put it simply, source extraction and cleaning using approved dust extractors are absolutely vital.



3-Phase Dust Extractors

Quality, Containment & Performance – All in one.



TROMB

DC Tromb Turbo

DC Tromb Turbo Twin

The DC Tromb Turbo Twin is the successor to the DC 3900 Turbo Twin and, like this, a very powerful dust extractor. It is particularly suitable for concrete grinding since 80–90% of the coarse materials are separated in the pre-separator. The remaining dust goes into the filter cyclone.



3-phase 

Part No DC Tromb Turbo Twin

173320 aa 2.2kW, EU
173340 LL 2.2kW, EU

Technical data

HxWxD [mm/in]	1415x600x 380/56x24x54
Weight [kg/lb]	a) Container 112/247 L) Longopac 112/247
Collection container [l/gal]	a) 40/10.6 L) Longopac
Flow max, fan, EU [m ³ /h]	249
Negative pressure, max, EU [kPa]	29
Power [kW]	2.2
Sound level [dB(A)]	72

Three-Phase Dust Extractors

With **direct start**

DC Tromb Turbo

The DC Tromb Turbo is a medium sized dust extractor that expands the Tromb family. It is equipped with a powerful three-phase turbo motor which is suitable for heavy cleaning (38 mm/1.5" accessories) and is delivered with 7 m hose. Suitable for source extraction from medium sized power tools such as grinders, jack hammers and saws. Thanks to the tall cyclone, large filters and powerful motor package, it can handle large amounts of debris.

Part No DC Tromb Turbo a/c/L

173500	a	2.2kW, EU
173100	c	2.2kW, EU
173300	L	2.2kW, EU
173502	a	4hp 460V /60Hz, US
173102	c	4hp 460V /60Hz, US
173302	L	4hp 460V /60Hz, US
173107	c	4hp 600V /60Hz, CAN

3-phase 



Supplied with (Part No)

Suction hose set, 7 m /23 ft, 5 m /16 ft (Ø50 mm /2") and 2 m /6.5 ft (Ø38 mm /1.5"), (2126)
 Floor nozzle B450 mm (7236)
 Suction pipe (Ø38 mm /1.5") (7257)
 Connecting sleeve (2114)
 Coupling socket (2107)
 Fine filter, polyester (44017)
 HEPA H13-filter (44016)
 a-model 5 x plastic bags (42285)

Technical data

HxWxD [mm/in]	1415x600x840/56x23x33
Weight [kg/lb]	a) Container 88/194 c) Bag 84/185 L) Longopac 86/190
Collection container [l/gal]	a) 40/10.6 c) 20/5.3 L) Longopac
Flow max, fan, EU [m³/h]	260
Flow max, fan, US/CAN [cfm]	186
Negative pressure, max, EU [kPa]	28
Power [kW]	2.2
Sound level [dB(A)]	72

With **frequency inverter (VFD)**

DC Tromb Turbo

DC Tromb Turbo is also available with a frequency inverter (VFD) and we would like to introduce the Longopac version. This model gives approx. 50% more filter area on the HEPA filter than its predecessor (5% more filter area for the fine filter). New safety features such as overheating protection is added. With the semi automatic filter cleaning and quick coupling for filter change, this machine gets the job done.

Part No DC Tromb Turbo VFD a/c/L

173400	a	2.2kW, EU
173000	c	2.2kW, EU
173200	L	2.2kW, EU

3-phase 



Supplied with (Part No)

Connecting sleeve (2129)
 Coupling socket (2008)
 Suction hose antistatic (Ø50 mm /2") 5 m/16 ft (2013)
 Floor nozzle B500 mm /W 19.7" (7238)
 Suction pipe (Ø50 mm /2") (7265)
 Fine filter, polyester (44017)
 HEPA H13 filter (44016)
 a-model 5 x plastic bags (42285)

Technical data

HxWxD [mm/in]	1415x600x840/56x23x33
Weight [kg/lb]	a) Container 96/212 c) Bag 92/202 L) Longopac 94/207
Collection container [l/gal]	a) 40/10.6 c) 20/5.3 L) Longopac
Flow max, fan, EU [m³/h]	400
Negative pressure, max, EU [kPa]	30
Power [kW]	2.2
Power Frequency Converter [kW]	4
Sound level [dB(A)]	84

Three-Phase Dust Extractors

DC Storm

Powerful, reliable and safe mobile dust extraction

The DC Storm is a powerful and reliable mobile dust extractor. They are built on a robust and sturdy steel chassis for maximum durability, for example on construction sites. With a direct-driven, three-phase turbopump, the DC Storm is suitable for continuous operation, conveying heavy material away, source extraction and cleaning.

The DC Storm provides sufficient air flow for several users at the same time and it can also be used as a semi-mobile central unit in a tubing system. It is suitable for source extraction for grinding discs up to approx. 800 mm/ 31" in diameter.

Three basic models are available: bag (c), container (a) and Longopac (L), each powered by a 4 kW, 7.5 kW or a 10 hp motor.

The DC Storm 700 is also equipped with a frequency converter, very useful when only 16A are available. This machine is equipped with a PTFE filter extracting large quantities of concrete dust and is suitable for example floor grinding.

Info of all our models – DC Storm 500, DC Storm 600 and DC Storm 700 is presented on the following pages.

Part No DC Storm 500 a/c/L

119400	c	400V /50Hz /4kW
119402	a	400V /50Hz /4kW
119430	L	400V /50Hz /4kW

3-phase



DC Storm 500 With plastic bag

Supplied with (Part No)

Coupling socket (2107)
Coupling socket (2008)
Suction hose (Ø50 mm /2") 7.5 m /22 ft (2401)
Floor nozzle B500 mm /W 19.7" (7238)
Suction pipe (Ø50 mm /2") (7265)
10 x plastic bags (46145)
Fine filter, polyester (44212)
HEPA H13 filter (42869)

Technical data

HxWxD [mm/in]	1790x780x1160/70x31x46
Weight [kg/lb]	178/392.4
Collection container [l/gal]	60/15.9
Flow max, fan, EU [m³/h]	500
Negative pressure, max, EU [kPa]	25
Power [kW]	4
Sound level [dB(A)]	75



DC Storm 500 With **container**

Supplied with (Part No)

- Coupling socket (2107)
- Coupling socket (2008)
- Suction hose antistatic (Ø50 mm /2") 7.5 m/22 ft (2013)
- Floor nozzle B500 mm /W 19.7" (7238)
- Suction pipe (Ø50 mm /2") (7265)
- Container 75 l /20 US gal (7368)
- Fine filter, polyester (44212)
- HEPA H13 filter (42869)

Technical data

HxWxD [mm/in]	1790x780x1160/70x31x46
Weight [kg/lb]	180/396.8
Collection container [l/gal]	75/19.8
Flow max, fan, EU [m³/h]	500
Negative pressure, max, EU [kPa]	25
Power [kW]	4
Sound level [dB(A)]	75



DC Storm 500 With **Longopac**

Supplied with (Part No)

- Coupling socket (2107)
- Coupling socket (2008)
- Suction hose antistatic (Ø50 mm /2") 5 m/16 ft (2013)
- Floor nozzle B 500 mm /W 19.7" (7238)
- Suction pipe (Ø50 mm /2") (7265)
- Longopac 25 m /82 ft (44077)
- Fine filter, polyester (44212)
- HEPA H13 filter (42869)

Technical data

HxWxD [mm/in]	1790x780x1160/70x31x46
Weight [kg/lb]	178/392
Collection container [mm/ft]	Longopac 25/82 flexible
Flow max, fan, EU [m³/h]	500
Negative pressure, max, EU [kPa]	25
Power [kW]	4
Sound level [dB(A)]	75

Three-Phase Dust Exctrators

DC Storm 600c

Supplied with (Part No)

Coupling socket (2107)
Coupling socket (2008)
Suction hose antistatic (Ø50 mm /2")
7.5 m/22 ft (2013)
Floor nozzle B500 mm /W 19.7" (7238)
Suction pipe (Ø50 mm /2") (7265)
10 x plastic bags (46145)
Fine filter, polyester (44212)
HEPA H13 filter (42807)

DC Storm 600a

Supplied with (Part No)

Coupling socket (2107)
Coupling socket (2008)
Suction hose antistatic (Ø50 mm /2")
7.5 m/ 22 ft (2013)
Floor nozzle B500 mm /W 19.7" (7238)
Suction pipe (Ø50 mm /2") (7265)
Container 75 l /20 US gal (7368)
Fine filter, polyester (44212)
HEPA H13 filter (42807)

DC Storm 600L PTFE

Supplied with (Part No)

Coupling socket (2107)
Coupling socket (2008)
Suction hose antistatic (Ø50 mm /2")
7.5 m/22 ft (2013)
Floor nozzle B500 mm /W 19.7" (7238)
Suction pipe (Ø50 mm /2") (7265)
Longopac 25 m /82 ft (44077)
Fine filter, PTFE (44081)
HEPA H13 filter (42807)

DC Storm 600

Technical data

HxWxD [mm/in]	1790x780x1160/70.5x31x45.5
Weight [kg/lb]	201/443
Collection container [l/gal]	60/13.6
Flow max, fan, US/CAN [cfm]	353
Negative pressure, max, US/CAN [inwg]	96
Power [hp]	10
Sound level [dB(A)]	75

Technical data

HxWxD [mm/in]	1790x780x1160/70.5x31x45.5
Weight [kg/lb]	203/447.5
Collection container [l/gal]	75/17
Flow max, fan, US/CAN [cfm]	353
Negative pressure, max, US/CAN [inwg]	96
Power [hp]	10
Sound level [dB(A)]	75

Technical data

HxWxD [mm/in]	1790x780x1160/70.5x31x45.5
Weight [kg/lb]	201/443
Collection container [mm/ft]	Longopac 20/65 flexible
Flow max, fan, US/CAN [cfm]	353
Negative pressure, max, US/CAN [inwg]	96
Power [kW]	7.4
Sound level [dB(A)]	75



Part No DC Storm 600c

119407 460V /60Hz /10hp, US
119436 220/380V /60Hz /10hp, US
119408 600V /60Hz /10hp, CAN

Part No DC Storm 600a

119409 460V /60Hz /10hp, US
119437 220/380V /60Hz /10hp, US
119410 600V /60Hz /10hp, CAN

Part No DC Storm 600L PTFE

119434 460V /60Hz /10hp, US
119435 220/380V /60Hz /10hp, US



Three-Phase Dust Extractors

DC Storm 700c

Supplied with (Part No)

Coupling socket (2107)
Coupling socket (2008)
Suction hose (Ø50 mm /2") 7.5 m/
22 ft (2401)
Floor nozzle B500 mm /W 19.7" (7238)
Suction pipe (Ø50 mm /2") (7265)
10 x plastic bags (46145)
Fine filter, polyester (44212)
HEPA H13 filter (42807)

DC Storm 700a

Supplied with (Part No)

Coupling socket (2107)
Coupling socket (2008)
Suction hose antistatic (Ø50 mm /2")
7.5 m/ 22 ft (2013)
Floor nozzle B500 mm /W 19.7" (7238)
Suction pipe (Ø50 mm /2") (7265)
Container 75 l /20 US gal (7368)
Fine filter, polyester (44212)
HEPA H13 filter (42807)

DC Storm 700L PTFE

Supplied with (Part No)

Coupling socket (2107)
Coupling socket (2008)
Suction hose antistatic (Ø50 mm /2")
7.5 m/22 ft (2013)
Floor nozzle B500 mm /W 19.7" (7238)
Suction pipe (Ø50 mm /2") (7265)
Longopac 25 m /82 ft (44077)
Fine filter, PTFE (44081)
HEPA H13 filter (42807)

DC Storm 700

The DC Storm 700 is also equipped with a frequency converter, very useful when only 16A are available. This machine is equipped with a PTFE filter extracting large quantities of concrete dust and is suitable, for example, floor grinding.

Technical data

HxWxD [mm/in]	1790x780x1160/70x31x46
Weight [kg/lb]	210/463
Collection container [l/gal]	60/15.9
Flow max, fan, EU [m³/h]	700
Negative pressure, max, EU [kPa]	22
Power [kW]	7.5
Sound level [dB(A)]	75

Technical data

HxWxD [mm/in]	1790x780x1160/70x31x46
Weight [kg/lb]	214/472
Collection container [l/gal]	75/20
Flow max, fan, EU [m³/h]	700
Negative pressure, max, EU [kPa]	22
Power [kW]	7.5
Sound level [dB(A)]	75

Technical data

HxWxD [mm/in]	1790x780x1160/70x31x46
Weight [kg/lb]	212/467.4
Collection container [l/gal]	Longopac 25/82 flexible
Flow max, fan, EU [m³/h]	700
Negative pressure, max, EU [kPa]	22
Power [kW]	7.5
Sound level [dB(A)]	75



Part No DC Storm 700c/a

119403 DC Storm 700c, 400V /50Hz VFD
119418 DC Storm 700a, 400V /50Hz VFD

Part No DC Storm 700L PTFE

119419 400V /50Hz /7.5 kW VFD

Three-Phase Dust Extractors

DC 5900 9.2kW S

This machine is primarily intended to be used for pneumatic conveying or the removal of very heavy material in conjunction with a pre-separator. The extra-large suction capacity can also be utilised for regular source extraction and cleaning, in situations where extra long hoses up to 50 m are required. To prevent overheating during intensive use, the pump has been equipped with a cold air intake.

The reverse pulse filter cleaning system provides extra-long filter life and ensures no loss of suction.

Part No DC 5900 9.2 kW S

119341 a 400V /50Hz
119340 c 400V /50Hz

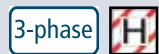

Supplied with (Part No)

Discharge

- a) 75 l /20 US gal container (40070)
- c) 10 x plastic bags (46145)

Fine filter, polyester (429204)
HEPA H13 filter (42807)

Technical data

HxWxD [mm/in]	1942x780x1160/76x30x45
Weight [kg/lb]	200/440.9
Collection container [l/gal]	a) Container 75/19.8 c) Bag 60/15.9
Flow max, fan, EU [m³/h]	500
Flow max, fan, US/CAN 115V [cfm]	294.3
Negative pressure, max, EU [kPa]	40
Negative pressure, max, US/CAN [inwg]	161
Power [kW]	9.2
Sound level [dB(A)]	75

DC 5900 9.2kW P

DC 5900 9.2kW P, is a powerful machine with sufficient capacity to support up to three users simultaneously with tasks such as cleaning with Ø38mm cleaning equipment and two more operators with hand-held grinders, saws, drills or with two users with Ø50mm cleaning equipment.

The machine is especially suitable for placed in the basement and with a standing Ø76mm pipe or hose system installed as a riser in stairwells. At each floor, you can then effectively connect the machine's hose through a manifold with flap valve.

Part no DC 5900 9.2kW P a/c/L

119301 a 60 l bag
119305 c 75 l container
119333 L Longopac
119336 L 460V /15hp 60Hz, US/CAN
119314 c 460V /15hp 60Hz, US/CAN
119315 a 460V /15hp 60Hz, US/CAN
119316 c 600V /15hp 60Hz, US/CAN
119317 a 600V /15hp 60Hz, US/CAN



Supplied with (Part No)

Discharge

- a) 75 l /20 US gal container (40070)
- c) 10 x plastic bags (46145)
- L) Longopac 25 m /82 ft (44077)

Fine filter, polyester (4292)
HEPA H13 filter (42807)

Technical data

HxWxD [mm/in]	1942x780x1160 /76x30x4
Weight [kg/lb]	210/463
Collection container [l/gal]	a) Container 75/19.8 c) Bag 60/15.8 L) Longopac
Flow max, fan, EU [m³/h]	800
Flow max, fan, US/CAN [cfm]	470.9
Negative pressure, max, EU [kPa]	28
Negative pressure, max, US/CAN [inwg]	112
Power [kW]	9.2
Sound level [dB(A)]	75

Accessoires for DC 5900 L 9.2 kW P (Part No)

Adaption Kit for Longopac (44248)



DC Tromb Turbo VFD Asbestos

Supplied with (Part No)

- Suction hose, antistatic, 5 m/16 ft (Ø50 mm /2") (2013)
- Floor nozzle B500 mm/19.7" (7238)
- Suction pipe (Ø50 mm/2") (7265)
- Connecting sleeve (2129)
- Coupling socket (2008)
- Fine filter, polyester (44017)
- HEPA H13 filter (44016)

Collecting variations:

- a-model, Steel container with 5 x plastic bags (42285)
- c-model, Intellibag , 10 x roll (43619)
- L-model, Longopac Mini Superstrong 4 x 23 m (432177)

We are expanding our Asbestos-line of dust extractors with 3 new machines: Tromb H Asbest Turbo VFD. This solution is especially developed for asbestos dust extraction that demands long operation times in large construction sites. The DC Tromb Turbo Asbestos is certified by the IFA* for asbestos removal. If you require extra long hose length for your asbestos operations, Tromb H Asbest Turbo VFD is the best choice. This powerful machine can be ordered with different selection of collection containers:

- a) Steel container
- c) Plastic bag - Intellibag
- L) Logongopac

Technical data

HxWxD [mm/in]	1390x600x840/55x23x33
Weight [kg/lb]	96/212 92/203 94/207
Collection container [l/gal]	40, 20, Longopac
Flow max, fan, EU [m³/h]	400/235
Negative pressure, max, EU [kPa]	30/120
Power Frequency Converter[kW]	4
Power Turbopump[kW]	2.2
Sound level [dB(A)]	84

Part No DC Tromb Turbo VFD Asbestos

- 176000 a 2.2KW/4HP EU
- 176100 c 2.2KW/4HP EU
- 176200 L TURBO VFD 2.2KW/4HP EU



DC 5900 H Asbestos

All DC 5900s are powerful and reliable mobile dust extractors. They are built on a robust and sturdy steel chassis for maximum durability. Now also for work in hazardous environments. The DC 5900 H Asbestos is certified by the IFA* for asbestos removal. Don't take risks with your health when removing asbestos!

4 kW Supplied with (Part No)

- Coupling socket (2107)
- Coupling socket (2008)
- Suction hose antistatic (Ø50 mm /2") 7.5 m /22 ft (2013)
- Floor nozzle B 500mm /W 19.7" (7238)
- Suction pipe (Ø50 mm /2") (7265)
- Plastic bag (46141)
- Fine filter, polyester (4292)
- HEPA H13 filter (42869)
- Container 75 l /19 US gal (7368)

9.2 kW P & S Supplied with (Part No)

- Fine filter, polyester, 9.2 kW S (4292)
- Fine filter, polyester, 9.2 kW P (429204)
- HEPA H13 filter (42807)



Part No DC 5900H Asbestos

- 119370 400V /4 kW 50 Hz
- 119350 400V /9.2 kW P 50 Hz
- 119360 400V /9.2 kW S 50 Hz

Technical data

	4 kW	9.2 kW P	9.2 kW S
HxWxD [mm/in]	1940x780x1160/76x30x45	1940x780x1160/76x30x45	1940x780x1160/76x30x45
Weight [kg/lb]	176/388	210/462	210/462
Collection container [l/gal]	75/19.8	75/19.8	75/19.8
Flow max, fan, EU [m³/h/cfm]	470/353	800/471	500/294
Negative pressure, max, EU [kPa/inwg]	28/112	28/112	40/160
Power [kW]	4	9.2	9.2
Sound level [dB(A)]	75	75	75

*The dust extractor has been DGUV tested and approved by IFA (Institut für Arbeitsschutz der Deutschen Gesetzlichen Unfallversicherung).







Compare our Dust Extractors

1-phase Dust extractor with one-motor

Technical data mini	DC 1800	DC 1800XL	DC 2900 c/a	DC 1800/2800 H Asbestos
HxWxD [mm/in]	780x405x390/31x16x15	1160x380x380/46x15x15	c) 1110x445x570/44x17x22	1800) 740x380x380/29x15x15
HxWxD [mm/in]			a) 1145x445x630/45x17x25	2800) 1110x440x550/43x17x21
Weight [kg/lb]	14/31	19/42	c) 16/35 a) 22/48	1800) 14 /31 2800) 19 42
Hose length Ø38 mm /1.5" [m/ft]	5/16	5/16	5/16	
Collection container [l/gal]	20/5.2	60/15.9	c) 20/5.3 a) 40/10.6	1800) 20/5.3 2800) 40/10.6
Flow max, fan, EU [m³/h]	205	205	205	205
Flow max, fan, UK 115V/230V [m³/h]	190/205	190/205	190/205	
Flow max, fan, US/CAN 115V [cfm]	126.5	126.5	126.5	126.5
Negative pressure, max, EU/UK [kPa]	24	24	24	21/24
Negative pressure, max, US/CAN [inwg]	84	84	96	96
Power 115/230V [W]	1340/1285	1340/1285	1284/1285	1340/1285
Sound level [dB(A)]	68	68	68	1800) 68 2800) 70
Filter area, fine/HEPA filter	1.5 m²/0.85 m² 16 ft²/9.1 ft²	1.5 m²/0.85 m² 16 ft²/9.1 ft²	1.5 m²/0.85 m² 16 ft²/9.1 ft²	1.5 m²/0.85 m² 16 ft²/9.1 ft²

1-phase Dust extractor with twin-motor

Technical data midi	DC Tromb H 400 a/c/L	DC Tromb H 400 Twin c/L	DC Tromb H 400 Asbestos	DC Chip Extractor
HxWxD [mm/in]	1390x600x780/55x23x31	1390x600x1280/55x23x50	1390x560x70/55x22x27	1530x600x780/60x23.5x31
Weight [kg/lb]	a) 50/110.2 c) 46/101.4 L) 50/110.2	cc) 71/168 cL) 80/173	50/110	69/152
Hose length Ø38 mm /1.5" [m/ft]	5/16	5/16	5/16	7.5/22
Collection container [l/gal]	a) 40/10.6 c) 20/5.3 L) Longopac	c) 20/5.3 L) Longopac	40/10.6	90/24
Flow max, fan, EU [m³/h]	420	420	393	355
Flow max, fan, UK 115V/230V [m³/h]	360/420	360/420		
Flow max, fan, US/CAN 115V [cfm]	212	212	231	
Negative pressure, max, EU/UK [kPa]	21 (+/- 10%)	21 (+/- 10%)	21/24	22
Negative pressure, max, US/CAN [inwg]	84	84	88	88
Power 115/230V [W]	2100/2680/3000	2100/2680/3000	3000	2600
Sound level [dB (A)]	70	70	70	70

3-phase Dust extractor

Technical data	DC Tromb Turbo VFD	DC Tromb Turbo Direct start	DC 5900 9.2 kW S	DC 5900 15 hp kW P
HxWxD [mm/in]	1390x600x840/55x23x33	1390x600x840/55x23x33	1942x780x1160/76x30x45	1942x780x1160/76x30x45
Weight [kg/lb]	a) 88/194 c) 84/185 L) 86/190	a) 6/212 c) 92/202 L) 94/207	200/440.9	210/463
Hose length Ø38 mm /1.5" [m/ft]	5/16	5/16	5/16	5/16
Collection container [l/gal]	a) 40/10.6 c) 20/5.3 L) Longopac	a) 40/10.6 c) 20/5.3 L) Longopac	a) 75/19.8 c) 60/15.8 L) Longopac	a) 75/19.8 c) 60/15.8 L) Longopac
Flow max, fan, EU [m³/h]	260	400	500	800
Flow max, fan, UK 115V/230V [m³/h]				
Flow max, fan, US/CAN 115V [cfm]	186		294.3	470.9
Negative pressure, max, EU/UK [kPa]	28	30	40	28
Negative pressure, max, US/CAN [inwg]	112	120	161	112
Power 115/230V [kW]	2.2	2.2	9.2	15 hp
Sound level [dB(A)]	72	84	75	75
Filter area, fine/HEPA filter	3.6 m²/3.0 m² 39 ft²/32.3 ft²	3.6 m²/3.0 m² 39 ft²/32.3 ft²	.6 m²/3.0 m² 39 ft²/32.3 ft²	3.6 m²/3.0 m² 39 ft²/32.3 ft²

Pressure generation and airflow of our machines

kPa vs m³/h

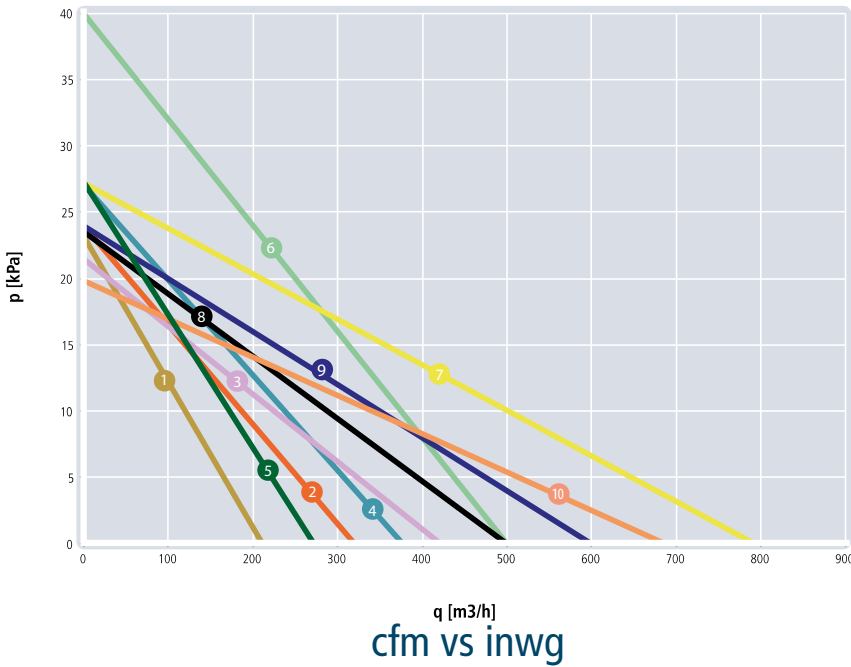

kPa vs m³/h

- 1 DC 1800 H, DC 1800 XL, DC 2900
- 2 DC Chip Extractor
- 3 DC Tromb H 400
- 4 DC Tromb Turbo – Direct Start
- 5 DC Tromb Turbo – Frequency Converter
- 6 DC 5900 9.2kW S
- 7 DC 5900 9.2kW P
- 8 DC Storm 500
- 9 DC Storm 600
- 10 DC Storm 700

cfm vs inwg

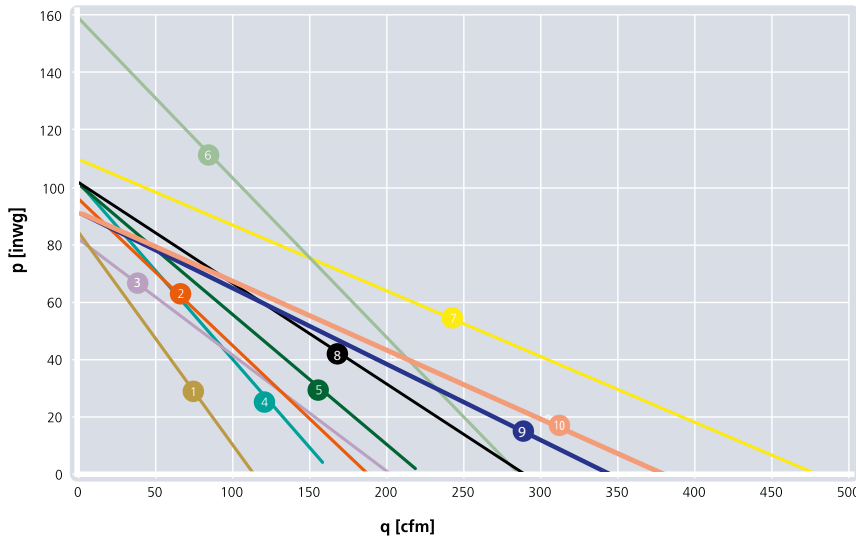

cfm vs inwg

- 1 DC 1800 H, DC 1800 XL, DC 2900
- 2 DC Chip Extractor
- 3 DC Tromb H 400
- 4 DC Tromb Turbo – Direct Start
- 5 DC Tromb Turbo – Frequency Converter
- 6 DC 5900 9.2 kW S
- 7 DC 5900 9.2 kW P
- 8 DC Storm 500
- 9 DC Storm 600
- 10 DC Storm 700

3-phase Dust extractor

Technical data

	DC Storm 500 c/a/L	DC Storm 600 c/a/L	DC Storm 700 c/a/L
HxWxD [mm/in]	1790x780x1160/70x31x46	11790x780x1160/70x31x46	11790x780x1160/70x31x46
Weight [kg/lb]	c) 178/392.4 a) 180/396.8 L) 178/392.4	c) 201/443 a) 203/447.5 L) 201/443	c) 210/463 a) 214/472 L) 212/467.4
Hose length Ø38 mm /1.5" [m/ft]	5/16	5/16	5/16
Collection container [l/gal]	c) 60/15.9 a) 75/19.8 L) 20/65 flexible	c) 60/15.9 a) 75/19.8 L) 20/65 flexible	c) 60/15.9 a) 75/19.8 L) 20/65 flexible
Flow max, fan, EU [m ³ /h]	500		700
Flow max, fan, UK 115V/230V [m ³ /h]			
Flow max, fan, US/CAN 115V [cfm]		353	
Negative pressure, max, EU/UK [kPa]	25		22
Negative pressure, max, US/CAN [inwg]		96	
Power 115/230V [Kw]	4	10	7.5
Sound level [dB(A)]	75	75	75
Filter area, fine/HEPA filter	5 m ² /2.7 m ² 54 ft ² /29 ft ²	5 m ² /2.7 m ² 54 ft ² /29 ft ²	5 m ² /2.7 m ² 54 ft ² /29 ft ²

Semi-Mobile Systems



A semi-mobile system increases the accessibility to a powerful dust extractor on each floor. Instead of moving several small and large dust extractors around, multiple users can simultaneously connect their machines or power tools via a hose to a connection point.

Semi-Mobile Systems

Semi-mobile dust collection systems are a practical solution when work is to be carried out on several floors and by several users at the same time. Each floor is connected to a central extraction system via a hose connection package and is equipped with a connection point for connecting the suction hose to the machine being used.

A Ø76 mm 1/3" hose that forms the main line is taken up through, for example, a lift shaft, refuse disposal chute or stairwell, and run to the dust extractor, which can in turn be connected to a pre-separator to collect larger particles, if necessary. One package is used for each floor to facilitate installation. The sound level is reduced and it becomes easy for each team to clean up regularly, once the task has been completed.



The Branch Pipe and Hose Connection Package (Prod No 3353) consists of

- 1 x Rubber plug with chain (4016)
- 1 x Hose, 2.5 m, 76 l (2024)
- 2 x Joint Ø76 mm 1/3" (remove rubber ring) (3007)
- 2 x Tube Ø76 mm 1/3" * 135 (3341)
- 1 x Screw 6*40 (MC6S)
- 1 x Branch pipe 45°, Ø76 mm 1/3" (300311)
- 1 x Flap valve Ø50/76 mm 1/2"1/3" (3006)

The Start Box (Prod No 8178)

The Hose Connection Package does not include electrical cables or the Start Box for vacuum producers (ordered separately).

The Start Box (8178)

Simultaneously Dust Extraction.

Several users can simultaneously connect their machines or power tools via the hose connection point.

One **Hose Connection Package** is used for each floor.

The **Start Box** is placed at the base level.

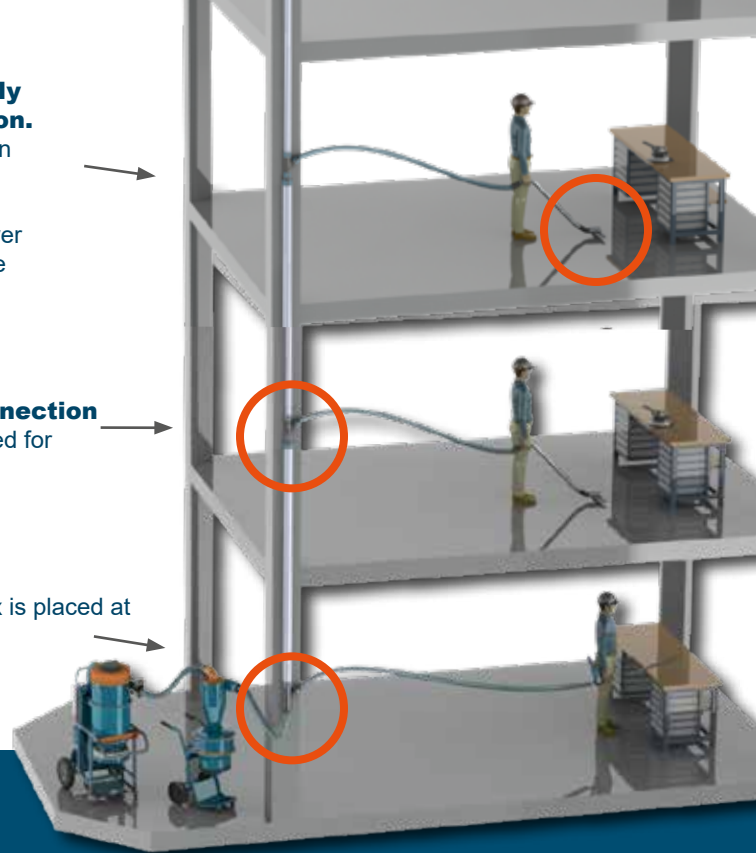

Hose Connection Package Part No 3353

Start Box Part No 8178

Powerful Dust Extraction

DC 5900 Part No 119320
DCF Storm Part No 70701





Wet-Vacs

for those of you who deal with larger quantities of water, we have developed a line of professional wet-vacs that can handle the toughest environments.

Wet-Vacs

DC 50W

Supplied with (Part No)

Coupling socket (2108)
Connecting sleeve (2114)
Suction hose Ø38 mm /1.5", 5 m /16ft, antistatic (2012)
Floor nozzle B370mm /W14"(7236)
Suction pipe Ø38, aluminium (7258)
Filter bag (42190)

Part No DC 50 W

118600 230V /50Hz, EU

1-phase



When drilling in concrete, large quantities of water are required, which becomes very dirty. Using a wet-vac to effectively extract the water prevents both the workplace from becoming wet and dirty, and the sewerage system from silting up. The slurry solids are collected in a filter bag for easy handling and disposal.

Dustcontrol's wet-vacs are easy to disassemble for cleaning and decontamination. This is an important benefit on units that require frequent cleaning. Robust construction helps these units resist the knocks from everyday use.

Technical data DC Wet-Vac 50 W

HxWxD [mm/in]	870x630x543/ 34x25x21
Weight [kg/lb]	34/75
Collection Container [l/gal]	50/13
Hose length Ø38 mm /1.5" [m/ft]	5/13.2
Flow max, open inlet EU [m³/h]	190
Negative pressure, max, EU [kPa]	21
Power [W]	
Vacuum motor, single-phase 230V	1285
Pump, single-phase [W]	550
Sound level [dB(A)]	75

DC 75W

Supplied with (Part No)

Coupling socket (2108)
Connecting sleeve (2115)
Suction hose Ø38 mm /1.5", 5 m /16ft, antistatic (2012)
Floor nozzle B370mm /W14"(7236)
Suction pipe Ø38, aluminium (7258)
Filter bag (42190)

Part No DC 75 W

118700 230V /50Hz, EU

1-phase



Technical data DC Wet-Vac 75 W

HxWxD [mm/in]	980x630x550/ 38x25x21
Weight [kg/lb]	37/81
Collection Container [l/gal]	75/19.8
Hose length Ø38 mm /1.5" [m/ft]	5/16
Flow max, open inlet EU [m³/h]	190
Negative pressure, max, EU [kPa]	21
Power [W]	
Vacuum motor, single-phase 230V	1285
Pump, single-phase [W]	550
Sound level [dB(A)]	75

Updates of DC Wet-Vac 75 W

Our DC 50W and DC 75W liquids extractors have been updated with a smaller electrical connector between the motor top and the pump. And a drain valve to easily drain water.

Note! When purchasing spare parts for the engine top for previous models (with a blue and larger electric connector), order part no 432138. The new motor top (with black and small electric connector) has part no 432138-1.





Air Cleaners



Air Cleaner

DC AirCube 500

DC AirCube 500 has been developed for ease of use and durability. The fan unit is a radial blower which is especially designed to build up high pressure across its entire flow range. This means that the unit generates a large amount of air flow during the entire lifetime of the filter. An exhaust hose can be used to create negative pressure in a sealed room. The fan has two speed settings, which means that the unit can be run economically, for example during the night.

Supplied with (Part No)

HEPA H13 filter (42692)
Pre-filter (42690)

Part No DC AirCube 500

112500 230V /50Hz, EU
112501 230V /50Hz, UK
112503 115V /50Hz, UK
112508 230V /50Hz, CH
112505 115V /60Hz, US/CAN
112509 230V /50Hz, AU

Accessories (Part No)

Hose Ø125 (2420)
Funnel connection (42753)
Hose clamp (4138)
Roof bracket (42724)

1-phase 

Technical data

HxWxD [mm/in]	380x340x495/ 15x13.4x19.5
Weight [kg/lb]	13/28.7
Inlet Ø [mm/in]	380x340/15x13.4
Outlet Ø [mm/in]	125/5
Power, fan 115/230 [W]	195/210
Flow max, open inlet 115V [m³/h/cfm]	470/276
Flow max, open inlet 230V [m³/h/cfm]	500/294
Pre-filter area [m²/ft²]	0.18/1.9
HEPA filter area [m²/ft²]	4.56/49
Filter class	H13
Sound level [dB(A)]	45-65



Accessories (Part No)

FILTERS FOR DC AIRCUBES

Go to page 81

HOSES & BENDS



Hose (42657)

Bend 90° (42660)

TRANSPORT COVERS



Ø125

AirCube 500 (45168)

Ø250

AirCube 1200 (45169)

Ø315

AirCube 2000 (45170)

HOSES, FUNNEL CONNECTION & HOSE CLAMPS

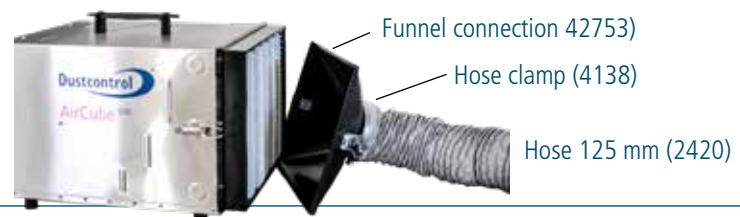

Funnel connection 42753

Hose clamp (4138)

Hose 125 mm (2420)

Air Cleaner

DC AirCube 1200

The DC AirCube 1200 is a highly efficient and robust air cleaner with the ability to clean the air even in large rooms, at a rate of up to 1060 m³/h /624 cfm. The encapsulated fan housing contains a radial blower type fan that builds up high pressure across its entire flow range, which provides effective air cleaning for the entire lifetime of the filter. The speed of the fan is also continuously variable in order to save energy. The DC AirCube 1200 is equipped with both a HEPA H13 filter that captures the smallest particles and a light that indicates when it is time to replace the filter.

Part No DC AirCube 1200

111000	230V /50Hz, EU
111001	230V /50Hz, UK
111002	115V /50Hz, UK
111008	230V /50Hz, CH
111003	115V /60Hz, US/CAN
111009	230V /50Hz, AU

1-phase



Supplied with (Part No)

HEPA H13 filter (42940)
Pre-filter (42918)

Accessories (Part No)

Hose kit (42657)
Bend 90° (42660)

Technical data

HxWxD [mm/in]	869x458x598/ 35x18x23.5
Weight [kg/lb]	23/51
Inlet/Outlet Ø [mm/in]	250/315 9.8/12.4
Power, fan 115/230 [W]	375/385
Flow max, open inlet 230V [m ³ /h/cfm]	1060/624
Pre-filter area [m ² /ft ²]	0.40/4.3
HEPA filter area [m ² /ft ²]	5/54
Filter class	H13
Sound level [dB(A)]	60-68

DC AirCube 2000

With a capacity of approximately 1.850 m³/h /1089 cfm the DC AirCube 2000 is the Dustcontrol's most powerful cleaner. The DC AirCube 2000 has a robust, stainless-steel chassis and an encapsulated fan with variable speed setting. With its ergonomic design, it is easy to carry and transport. It can also be operated when positioned horizontally.

The DC AirCube 2000 has a HEPA H13 filter with an area totalling 10 m² /107 ft². An integrated light indicates when it is time to replace the filter.

Part No DC AirCube 2000

102000	230V /50 Hz, EU
102002	230V /50 Hz, UK
102003	115V /50 Hz, UK
102008	230V /50 Hz, CH
102004	115V /60 Hz, US/CAN
102009	230V /50Hz, AU

1-phase



Supplied with (Part No)

HEPA H13 filter (42896)
Pre-filter (42917)

Accessories (Part No)

Hose kit (42657)
Bend 90° (42660)

Technical data

HxWxD [mm/in]	1019x512x547 /40x20x21.5
Weight [kg/lb]	30/66
Inlet/Outlet Ø [mm/in]	315/315 12.4/12.4
Power, fan 115/230 [W]	375/750
Flow max, open inlet 230V [m ³ /h/cfm] max	1850/1089
Pre-filter area [m ² /ft ²]	0.5/5.4
HEPA filter area [m ² /ft ²]	10/107
Filter class	H13
Sound level [dB(A)]	60-68



Dustcontrol

Part no 4613 Dustcontrol Part n

A photograph of a decontamination system, likely a glovebox or hot cell. The image shows a dark, heavy-duty metal structure with a viewing window on the left side. Inside the chamber, a white perforated tray is visible. A prominent feature is a thick, black, coiled cable that hangs vertically from the top of the chamber. The interior is brightly lit, creating a strong contrast with the dark exterior. The overall scene suggests a controlled, hazardous environment where safety and containment are paramount.

Decontamination Systems

Compact Vacuum Systems

DC Box

The DC Box is a especially designed dust extraction cabinet that protects against hazardous dust during decontamination and cleaning before servicing or repairing machines and tools. The DC Box is equipped with a blow gun and a suction hose for vacuum cleaning. Larger particles and debris fall down into the collection container a plastic bag attached to the bottom of the cabinet.

The DC Box is easy to work with. Tools and machines are placed onto the rotating worktable and slid in through the side door. These are then cleaned either by vacuuming or using compressed air. The fine dust is vacuumed up and transported away via a tubing system to a complete central unit located either in- or outdoors.

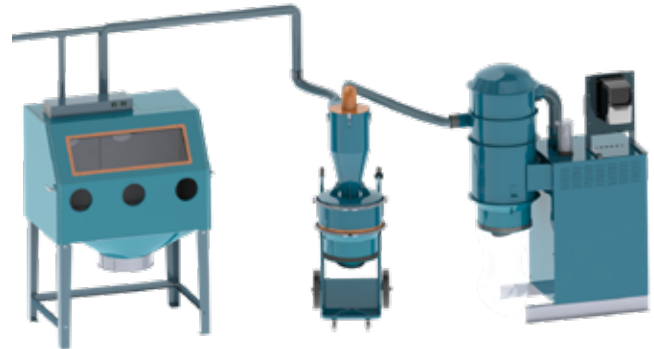

DC Box

DCF Tromb

DC 11-Module

Installation example for our DC Box.

Standard or Custom?

The DC Box is available in two versions: Standard and Custom:

DC Box Standard is the ideal solution for most users. This solution has now been updated with a selection of 3 discharge options: Container (A), Intelli-bag (C) or Longopac (L) as standard.

Some more new features of DC Box Standard:

- The outlet on the top of the DC-Box has been enlarged to D108 instead of the previous D76.
- The user can adjust the working height as the legs are now adjustable.
- The outer dimensions of the box have also been adjusted to fit on a standard European pallet. Safer and more cost-effective transportations!

DC Box Custom. If you want to be able to roll taller equipment directly into the cabinet for decontamination, then the DC Box Custom is the solution for you. DC Box Custom is customised after your requirements.

The size of the central unit and dimensioning of the tubing system is tailored to the needs of the projects. The system can be expanded so that it can also be used as a central extraction system with connections that are easily accessible across the entire worksite.



DC Box Custom

DC BOX Custom (Part No)

Part no 7470	DC BOX
Part no 72014	TROLLEY
Part no 7999	DC BOX CUSTOM

Contact our sales representative for a quotation DC Box Custom.

Compact Vacuum Systems



Compressed air connection and blow gun nozzle. Suction hose for easy cleaning inside the cabinet.

DC Box Standard

DC BOX Standard (Part No)

Part no 7480 DC BOX STANDARD A
Part no 7481 DC BOX STANDARD C
Part no 7482 DC BOX STANDARD L



UPDATES

The former solution DC Box Compact is discontinued. In the DC Box Compact solution a DC AirCube 500 was connected as standard. However if ventilation of the DC Box with an air cleaner is desired, it can be connected to the D108 outlet of

our new solution DC Box Standard. Shutter valves and tubing systems that previously came as standard for DC Box Standard will now have to be selected separately instead.

DC Box Standard

TECHNICAL DATA

DC Box Standard

HxWxD [mm/in]	1620-1770 x 1155 x 760 / 63.8 - 69.7 x 45.5 x 30
Weight [kg/lb]	160/353
Outlet Ø [mm/in]	108 x 1.50 x 1 / 4.25 x 1.2 x 1
Nominal pressure drop [kPa] / [inwg]	3.5 / 14.1
Nominal flow [m ³ /h] / [CFM] (EU) [m ³ / h] / (US / CAN) [CFM] [m ³ /h / cfm]	700 / 412
Voltage [V]	230

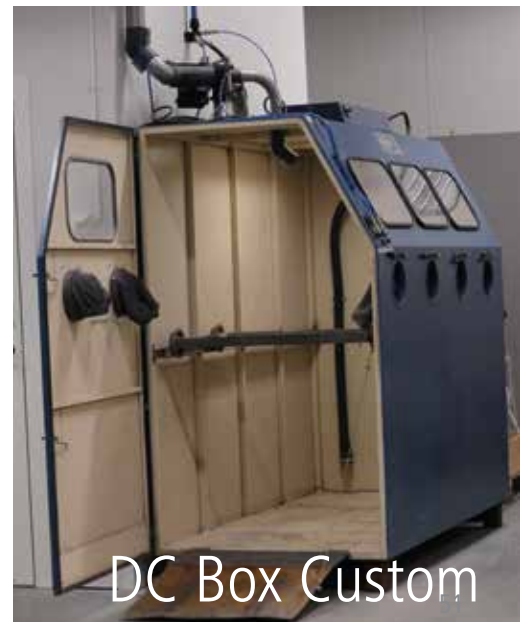

DC Box Custom



Pre-Separators

About Pre-Separators

Pre-Separators can be used in all applications where the extracted material is coarse or voluminous. These can be placed in the actual workplace for separate handling or recovery of the extracted material, or centrally to relieve filter loading.

Pre-Separators separate material from the air flow using the action of a cyclone or with inertial separation.

The Cyclone Principle is very effective in separating particles down to 1/100 mm.

Inertial separators are generally configured as containers with the inlet and outlet in the same wall of the container. When the air flow changes direction abruptly, separation occurs for the particles with higher relative mass.

Cyclone Pre-Separators

TYPE OF MATERIAL	Air flow [m ³ /h]	Select Pre-Separator
All types, particularly where a large percentage is fine particulate	100–200	DCF 60, F 2500, DCF 2800
	100–500	DCF Mobil
	200–500	F 3500
	500–700	F 8000
	500–1000	F 11000
	1000–4000	F 20000
	2000–5000	F 30000

DISCHARGE TO	Volume	Equipment
Plastic bag	lesser	Discharge cone
Compacted in plastic bag	greater	Auger Compactor
Open Container, Conveyor	lesser	Foot Valves/Auto Foot Valve/ Discharge Valves
	greater	Peristaltic Airlock
Small Container	lesser	With or without plastic bag
Tipping Container	greater	

Inertial Pre-Separators

MATERIAL TYPE	Air flow [m ³ /h]	Volume	Select Pre-Separator
Coarse and dense	250-2000	moderate	Tipping Container
	250-2000	large	Large Container



Cyclone Principle

Meaning that the inlet is mounted tangentially on the body and the air flow is thus forced against the inside of the cyclone.

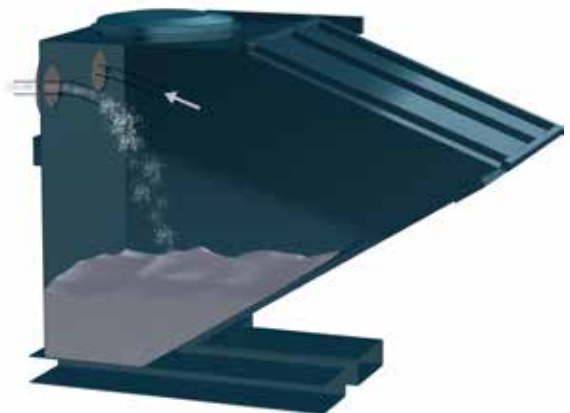

Inertial Principle

Meaning that the air stream flows into the container and abruptly changes course.

Mobile Pre-Separators

DCF Tromb

The DCF Tromb a/c/L is ideal for floor grinding and semi-mobile systems where large quantities of dust are handled. The pre-separator reduces the strain on the extraction source and is equipped with a intellibag/Longopac/container-solution for dust-free bag replacement, therefore allowing the user to avoid unnecessary and time-consuming shutdowns.

TECHNICAL DATA	DCF Tromb
HxWxD [mm/in]	1415x600x780/56x23x31
Weight [kg/lb]	L) 32/70 C) 27/59
Inlet Ø [mm/in]	76/3
Collection container [l/gal]	C) 20/5.3 L) Longopac



Part No	Description
707002	DCF Tromb a
707001	DCF Tromb c
707000	DCF Tromb L



Supplied with (Part No)

- DCF Tromb a
5 x plastic bags (42285)
- DCF Tromb c
10 x plastic bag (43619)
- DCF Tromb L
Longopac (432177)

DCF Storm

The DCF Storm is ideal for floor grinding and semi-mobile systems and could be set apart to handle large and heavy quantities of dust. The pre-separator relieves the loading on the filter in the vacuum source and is equipped with a Longopac solution for dust-free bag changing, so that the user can minimise unnecessary and time-consuming stoppages. Also available as a standard “c” model with an intellibag.

TECHNICAL DATA	DCF Storm
HxWxD [mm/in]	185x70x108 /73x27x42
Weight [kg/lb]	46/101
Inlet Ø [mm/in]	108/4
Flow max, fan, EU [m³/h]	700
Flow max, fan, US/CAN [cfm]	412



Part No	Description
70700	DCF Storm c
70701	DCF Storm L



Supplied with (Part No)

- DCF Storm c
plastic bags (46145)
- DCF Storm L
Longopac 25 m /82 ft
(44077)

Mobile Pre-Separators

DCF Cyclone Separator Cover

When large quantities of dust are produced, a DC 5900, for example, can be supplemented with a cyclone separator cover that is fitted directly onto a standard barrel.

Part No Description

7367 Cyclone separator cover

TECHNICAL DATA	DCF Storm
HxWxD [mm/in]	580/23
Weight [kg/lb]	10/22
Inlet/Outlet Ø [mm/in]	76/3
Cyclone diameter Ø [mm/in]	Ø250/10
Barrel diameter Ø [mm/in] (For a standard barrel 200/52.8 [l/gal])	620/24



DCF 60

The DCF 60 Pre-Separator can handle large quantities of dust. Due to its large inlet the Pre-Separator is also well suited to separate coarse dirt. Perfect for wood floor grinding.

Part No Description

7069 DCF 60 with wheel set

TECHNICAL DATA	DCF 60
HxWxD [mm/in]	1060x380x380/42x15x15
Weight [kg/lb]	10/22
Inlet Ø [mm/in]	Ø62 /2.4
Outlet Ø [mm/in]	Ø50 /2
Collection container [l/gal]	55/14.5



DCF 2900 c/L

The DCF 2900 Pre-Separator is often used in combination with the DC 2900 dust extractor to relieve the loading on the filter. Two models available, with bags (c) or with Longopac (L).

Part No Description

7372 DCF 2900 c
737200 DCF 2900 L

TECHNICAL DATA	DCF 2900 c/L
HxWxD [mm/in]	1000x540x450/39x21x18
Weight [kg/lb]	c) 10/22 L) 15/33
Inlet Ø [mm/in]	Ø50/2
Cyclone diameter [mm/in]	Ø250/10
Collection container [l/gal]	c) 40/10 L) Longopac



Supplied with (Part No)

42702 Plastic Bags
44763 Longopac mini, 7 x 12 m/39ft





DCF Wheelbarrow

The DCF Wheelbarrow is a mobile pre-separator designed like a wheelbarrow for ease of use. A small cyclone with two inlets is fitted in the container. Two tools, cleaning implements etc. can be connected at the same time. The container also has a special hatch so that material can be shovelled in and out.



TECHNICAL DATA DCF Wheelbarrow

HxWxD [mm/in]	1200x1350x640 /47x53x25
Weight [kg/lb]	50/110
Inlet/Outlet Ø [mm/in]	Ø76/3
Cyclone diameter Ø [mm/in]	Ø250/10
Filling volume [l/gal]	120/32

Part No Description

7130	DCF Wheelbarrow
------	-----------------

DCF Tipping Container

Tipping containers can be used as inertial separators by equipping the container with a divider baffle and fitting hoses onto the inlet/outlet connections on the rear wall of the container.

Inertial separation is particularly suitable when large quantities of coarse material are involved.



TECHNICAL DATA DCF Tipping Container 0.6m³/158 gal

HxWxD [mm/in]	1180x1080x1590 /46x42x62
Weight [kg/lb]	240/529
Total volume [m³/gal]	0.6/158
Filling volume [m³/gal]	0.3/79
Negative pressure, max [kPa/inwg]	40/160

TECHNICAL DATA DCF Tipping Container 2.5m³/660 gal

HxWxD [mm/in]	147x128x218 /58x50x86
Weight [kg/lb]	570/1257
Total volume [m³/gal]	2.5/660
Filling volume [m³/gal]	1.3/343
Negative pressure, max [kPa/ inwg]	40/160

Part No Description

7196	0.6 m³/158 gal
7198	2.5 m³/660 gal



The most hazardous dust is the dust you can't see.

The smaller a particle is, the deeper into the pulmonary system it penetrates. Respirable dust, the dust we inhale, is made up of particles smaller than 5 thousands of a millimetre (5 μm). Because the particles are so small, they can penetrate into the deepest parts of the pulmonary system where the air moves too slowly to be able to breathe them out again.

The lungs' way of protecting themselves is to wrap the foreign particles in nodules of connective tissue, which, in time, leads to pneumoconiosis or COPD (Chronic Obstructive Pulmonary Disease). Some types of particles, such as silica and asbestos dust, cannot be broken down by the body and are also sharp, which is why they continue to cause damage long after they have become lodged in the lungs.

The best protection is to remove dust at the source and never allow it to reach the air. Dustcontrol has developed suction casings for most handheld and stationary machines, and also produces tailor-made suction casings.

Classification of Dust Extractors and HEPA Filters

Dust extractors are used to improve the working environment, and to reduce levels of hazardous dust in the air to a minimum. This places great demands on the ability of the dust extractor to separate fine dust. We use a fine filter in our mobile dust extractors, which separates most of the dust. But in order to capture close to 100% of the finest and most dangerous particles, we always complete the design with a HEPA H13 filter.

Here at Dustcontrol, we use conical pleated filters in all of our dust extraction units. A pleated filter has a very large area in relation to its physical size. The dust extractors can therefore be compact in relation to the large filter area they contain.

Only original Dustcontrol filters are tested and approved for use in our machines. The use of other types of filters could lead to the leaking of hazardous dust and/or machine breakdown. Dustcontrol's warranty only applies to machines equipped with original Dustcontrol spare parts. The filters are certified in accordance with current European requirements for dust extraction. This ensures that, with correct handling, optimum filtration will be achieved. Follow the instructions when handling filters, so that they can be replaced without exposure to hazardous dust.

To ensure that the filters comply with the requirements of relevant regulations for health and safety at work, a number of different testing standards are used. These are described below:

Test methods

The test methods used in current standards for dust extractors and filters are always based on particle counting. By injecting particles before the filter and by using a particle counter to determine the concentration before and after the filter, the penetration can be calculated (a penetration of 0.1% is equal to a degree of separation of 99.9%). The test is carried out in several

stages by individually examining the filter media, the complete filter cartridge and, in some cases, also the complete unit.

HEPA filters — High Efficiency Particulate Air Filters

When classifying HEPA filters, Dustcontrol uses the strict HEPA standard (EN 1822-1). It is divided into different levels (E10 to H14) depending on filtration efficiency. Dustcontrol applies level H13, which can separate up to 99.95% of the particles between 0.15 and 0.30 µm in size. This particle size is used because it is the hardest to separate – both larger and smaller particles are easier to capture in a filter.

Dust extractors

In IEC-60335-2-69 (EN-60335-2-69), the standard for testing wet and dry extractors, dust extractors are classified into three categories – **L for low, M for medium and H for high** – where the H category is the most stringent. (Please note: do not confuse this “H” with that in HEPA H13). The category required for a specific application is decided on the basis of the permitted maximum concentration for that type of dust (MAK) in the working environment or by local regulations.

The test according to EN-60335-2-69 comprises two parts:

1. A test of the filter system – in our case, a fine filter and a HEPA H13 filter. To achieve category H, a degree of separation of 99.995% is required, where 90% of the test particles must be smaller than 1.0 µm. Our fine filters comply with category M, and our HEPA H13 filters with category H.

2. A test of the “assembled unit” – in our case, a complete dust extractor. Here, 99.995% efficiency is also required, however 10% of the particles must be smaller than 1.0 µm, 22% smaller than 2.0 µm, and 75% smaller than 5.0 µm.



The filter systems in all Dustcontrol dust extractors are built to comply with the stringent IEC machine classification H.

Dustcontrol's high-efficiency air cleaner – the DC AirCube – is equipped with a HEPA H13 filter to separate dust and particles down to 0.3 microns. The DC AirCube contributes to a healthier working environment.



Dust class H (degree of permeability $\leq 0.005\%$) for particles as small as 0.1 mg/m³ and carcinogenic particles. According to IEC/EU 60335-2-69

Classification of our Dust Extractors



NAME	CLASSIFICATION	STANDARD	EFFICIENCY	PARTICLE SIZE	EXAMPLE	MAK (Maximum Workplace Concentration)
	L=		> 99%			> 1.0 mg/m ³
	M=		> 99,9%			> 0.1 mg/m ³
IEC* standard	H=	IEC 60335-2-69	> 99.995%	0.1 - 5.0 µm**	H=99.995%	< 0.1 mg/m ³ and carcinogenic substances including asbestos

* IEC: International Electrotechnical Commission

** Part 1: 90 % < 1.0 µm

Part 2: 10 % < 1.0 µm
22 % < 2.0 µm
75 % < 5.0 µm

Classification of our HEPA Filters



NAME	CLASSIFICATION	STANDARD	EFFICIENCY	PARTICLE SIZE	EXAMPLE
	E10		85%	MPPS** between 0.15–0.30 µm	
	E11		95%		
	E12		99.5%		
HEPA*	H13	EN 1822-1	99.95%		HEPA H13 = 99.95 %

* High Efficiency Particle Air filter, ** Most Penetrating Particle Size



Accessories and Hoses



In order for you to get the most out of your Dustcontrol, you need the right accessories. We supply cleaning equipment in all sorts of designs and materials. If something is missing, we can even manufacture customised solutions. Please speak to your sales representative for more information.

Accessories and Consumables

Cleaning accessories Ø38 mm / 1.5"



No	Part No	Description
1	7038	Suction nozzle
2	7047	Suction brush W 200 mm / 7.8"
3	7048	Pipe nozzle RB 100
4	7049	Pipe nozzle RB 200
5	7276*	Tapered nozzle
6	7365	Flat nozzle
7	7257	Suction pipe Ø38 mm / 1.5"
8	7258	Aluminium wand
9	7259	Aluminium wand, with wear strip
10	7260	Chrome steel extension wand, L = 715 mm / 28"
11	7261	Aluminium extension wand, L = 705 mm / 27"
12	7264*	Tapered nozzle
13	7213	Chrome steel flat nozzle, L = 400 mm / 15.7"
14	7035	Chrome steel hand pipe
15	7262	Chrome steel hand pipe, curved
16	7235*	Cast aluminium floor tool 370 mm / 14.5"
17	7236*	Cast aluminium floor tool 450 mm / 17.7"
18	7320/21	Moulded plastic floor tool 320 mm / 12.6", with rubber wipe/brush
19	7322/23	Moulded plastic floor tool 370 mm / 14.5", with rubber wipe/brush
20	7300	Rubber floor tool
21	7278*	Suction brush
22	7275	Rubber part of suction brush, 7278
23	7263	Brush for 7275, 7278
24	726301	ESD brush for 7278, 7279
25	7398	Brush for 7278, 7279, hard, white
26	7237*	Cast aluminium floor tool 370 mm / 14.5", with wipe/brush



* To order an antistatic (ESD) version, add E to the end of Part No.

Accessories and Consumables

Cleaning accessories Ø50 mm / 2"



ERGO Grip for better ergonomoy.
Fits on all Ø50 mm / 2" suction
pipes and Ø50 mm / 2" bulk nozzle.



* To order an antistatic (ESD) version,
add E to the end of Part No.

No	Part No	Description
1	7266	Aluminium wand
2	7267	Aluminium wand, with wear strip
3	7265	Chrome suction pipe Ø50 mm/ 2"
4	7268	Chrome steel extension wand, 710 mm/28"
5	7033	Chrome steel hand pipe
6	7271	Chrome steel hand pipe, curved
7	7285	ERGO Grip handle
8	7272*	Tapered nozzle
9	7277*	Tapered nozzle
10	7212	Flat nozzle, L = 400 mm /15.7"
11	7295	Bulk nozzle
12	7013	Rubber floor tool
13	7281*	Floor nozzle W 200 mm /7.8"
14	7238*	Cast aluminium floor tool, 500 mm/19.6"
15	7307	Gulper floor tool, aluminium
16	7149	Chip nozzle 50x70x243 / 1.9"x2.7"x9.6"
17	7030	Suction nozzle
18	7279*	Suction brush
19	7016*	Suction nozzle with brush
20	7274	Rubber part for suction brush
21	7263	Brush for 7274, 7279
22	726301*	ESD brush for 7278, 7279
23	7398	Brush for 7278, 7279, hard, white

Accessories and Consumables

Cleaning accessories $\varnothing 76$ mm / 3"

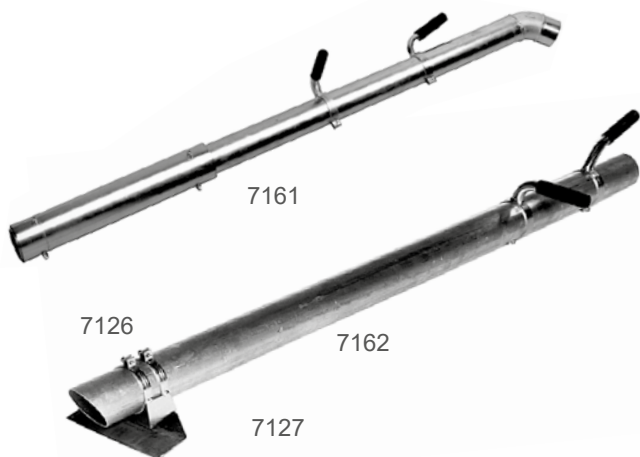

Part No	Description
7126	Clamp for scraper
7127	Scraper for suction lance
7129	Handle, complete
7161	Bulk nozzle
7162	Suction lance

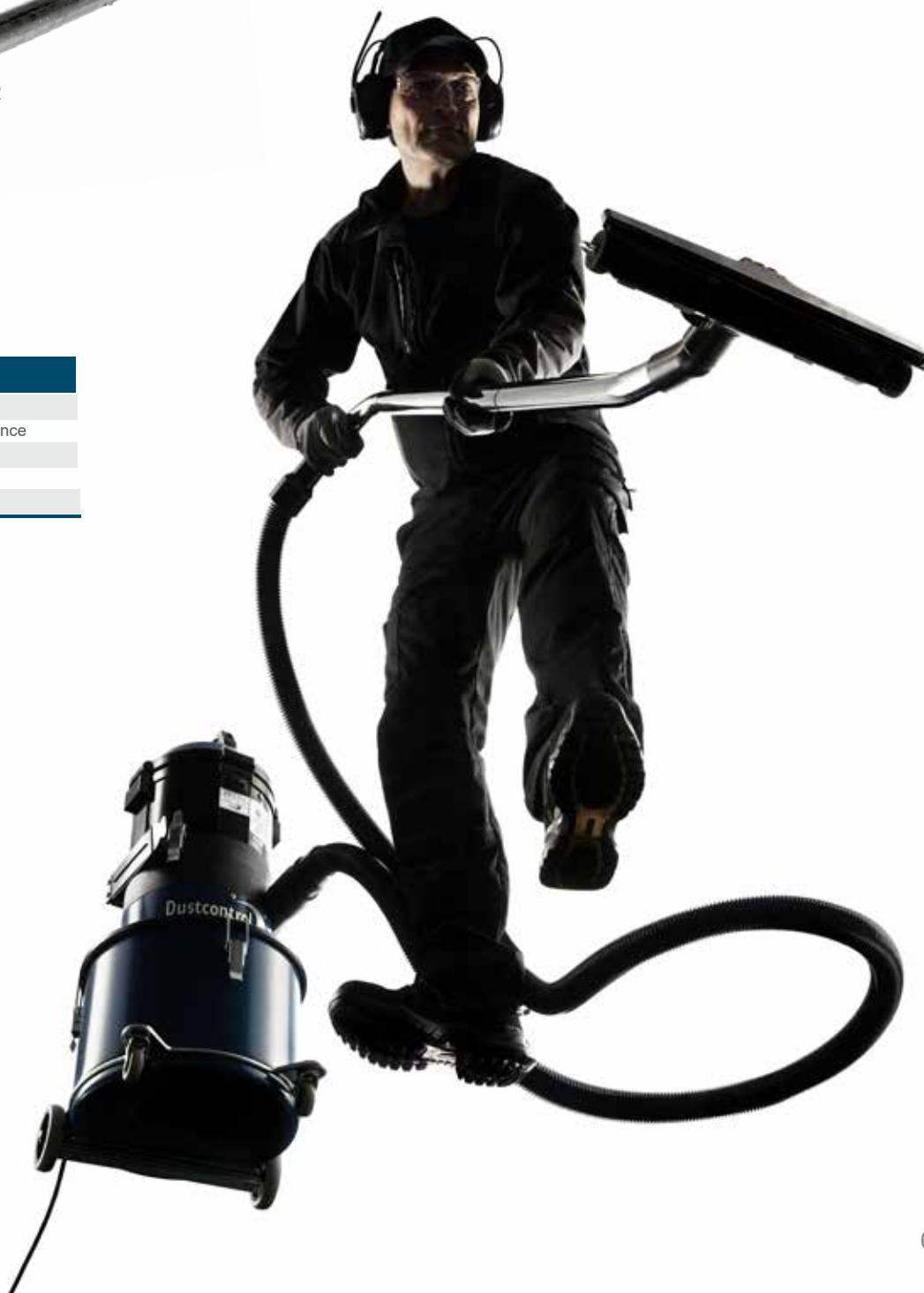

About Suction Hoses

Hoses need to have different characteristics depending on their intended use. Dustcontrol supplies hoses that are:

- wear-resistant, lightweight and flexible
- unaffected by extremes of temperature
- crushproof
- antistatic

When using long suction hoses that are coupled together, the hose closest to the suction casing should be the one with the smallest diameter and it should be no longer than 9,8 ft /3 m. Coupling should be carried out using external couplings that are easy to use.

Our selection of Suction Hoses

PRODUCT	Part No	Dimension Ø [mm/in]	Standard length [m/ft]	Colour	Material	Temp °F /°C max/min	Anti-static/ESD	Abrasion resistance	UV and ozone resistance	Resistance to welding fumes	Resistance to solvent and oil	FDA
Suction hoses, standard	2001	76/3	10,15 /32,49	Blue	PE	140/-22/+60/-30	No	2	2	3	3	
	2401	50/2	5,10,15,20,25,30/16,32,49,65,82,98	Blue	PE	140/-22/+60/-30	No	2	2	3	3	
	2111	38/1.5	5,10,15,20,25,30/16,32,49,65,82,98	Blue	PE	140/-22/+60/-30	No	2	2	3	3	
	2112	32/1.25	5,10,15,20,25,30/16,32,49,65,82,98	Blue	PE	140/-22/+60/-30	No	2	2	3	3	
	2113	25/1	5,10,15,20,25,30/16,32,49,65,82,98	Blue	PE	140/-22/+60/-30	No	2	2	3	3	
Suction hoses, heat-resistant	2004	50/2	5,10,15 /16,32,49	Grey	PP(EPDM)	194/-40/+90/-40	No	3	2	1	4	
	2003	38/1.5	5,10,15 /16,32,49	Grey	PP(EPDM)	194/-40/+90/-40	No	3	2	1	4	
Suction hoses, antistatic	2024*	76/3	5,10,15 /16,32,49	Black	PE	140/-4/+60/-20	Yes	2	2	3	3	
	2013*	50/2	5,10,15,20 /16,32,49,65	Black	PE	140/-4/+60/-20	Yes	2	2	3	3	
	2012*	38/1.5	5,10,15,20 /16,32,49,65	Black	PE	140/-4/+60/-20	Yes	2	2	3	3	
	2005*	32/1.25	5,10,15,20 /16,32,49,65	Black	PE	140/-4/+60/-20	Yes	2	2	3	3	
	2025*	25/1	5,10,15,20 /16,32,49,65	Black	PE	140/-4/+60/-20	Yes	2	2	3	3	
Hose, ATEX	2027*	38/1.5	5,10,15,20 /16,32,49,65	Black	PE	140/-4/+60/-20	Yes	2	2	3	3	
	2028*	50/2	5,10,15,20 /16,32,49,65	Black	PE	140/-4/+60/-20	Yes	2	2	3	3	
Suction hoses, PU extra abrasion-resistant	2056	76/3	10/32	Transparent	PU	194/-40/+90/-40	Yes**	1	1	3	1	
	2054	50/2	10/32		PU	194/-40/+90/-40	Yes**	1	1	3	1	
	2055	38/1.5	10/32		PU	194/-40/+90/-40	Yes**	1	1	3	1	
Super D superelastic	2038	38/1.5	15/49	Black/white	PVC	185/-23/+85/-5	No	2	2	2	4	
	2039	50/2	15/49	Black/white	PVC	185/-23/+85/-5	No	2	2	2	4	
Suction hose	44140	38/1.5	10/32	Transparent	PU	-40 to +90		2	2	2	2	x
Suction hose	44141	50/2	10/32	Transparent	PU	-40 to +90		2	2	2	2	x
Suction hose	44142	76/3	10/32	Transparent	PU	-40 to +90		2	2	2	2	x

Resistance Scale

- 1 Excellent
- 2 Good
- 3 Limited
- 4 Poor



* To order an antistatic (ESD) version, add the letter E to the end of the Part No.

** The wire helix must be bared and left in contact with conductive material for static discharge.

Suction Hoses

Turnable Hose Connectors

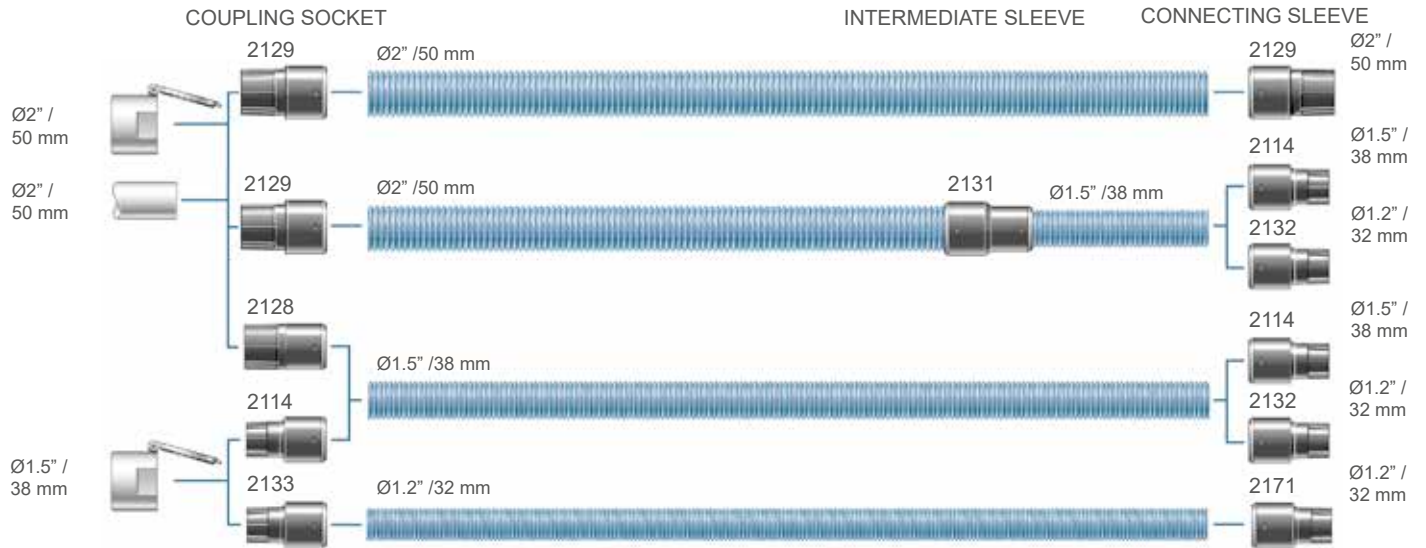

Part No	Description
2114*	Connecting sleeve, turnable Ø1.5"/1.5" /38/38
2128*	Coupling sleeve, turnable Ø2"/1.5" /50/38
2129*	Coupling sleeve, turnable Ø2"/2" /50/50

Part No	Description
2131*	Intermediate sleeve, turnable Ø2"/1.5" /50/38
2132*	Connecting sleeve, turnable Ø1.2"/1.5" /32/38
2133*	Coupling sleeve, turnable Ø1.5"/1.2" /38/32
2171*	Coupling sleeve, turnable Ø1.2"/1.2" /32/32



*To order an antistatic (ESD) version, add E to the end of Part No.

Suction Hose Quick Coupler

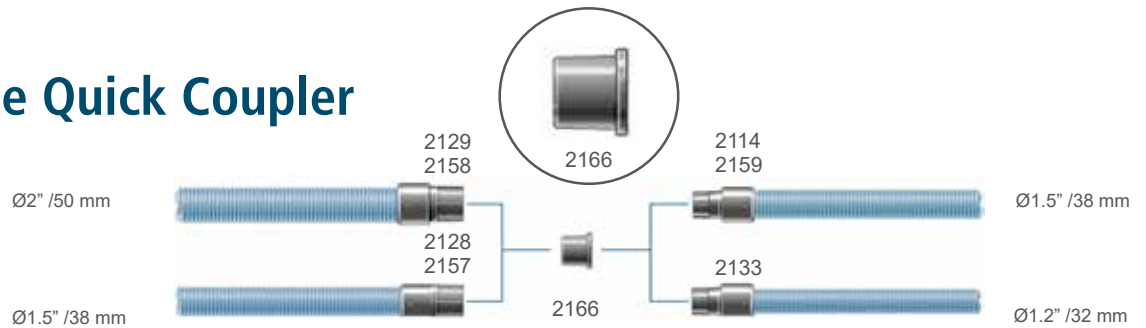

Multi-Connection for Hand-held Power Tools with Integrated Suction Casings

The multi-connection fits onto suction casings with an outlet diameter of 0.98-1.37 inch /25-35 mm. Cut off a section at the required diameter (it is pre-marked with: 25, 27, 29, 31, 33, 35 mm) and slip the multi-connection over the tubing. Connection sleeves 2114 or 2115 then fit onto the other end to connect the hose.

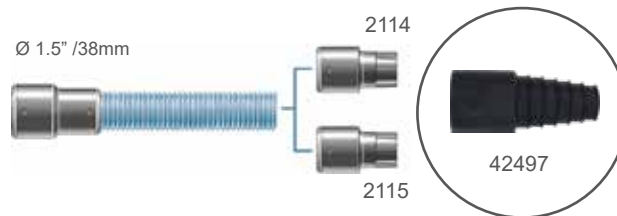

Part No	Description
42497*	Multi-connection for hand-held power tools with integrated suction casings
2114*	Coupling socket Ø1.5/1.5" 38/38 mm, turnable
2115*	Coupling socket Ø1.5/1.5" 38/38 mm

Suction Hoses

Non-Turnable Hose Connectors

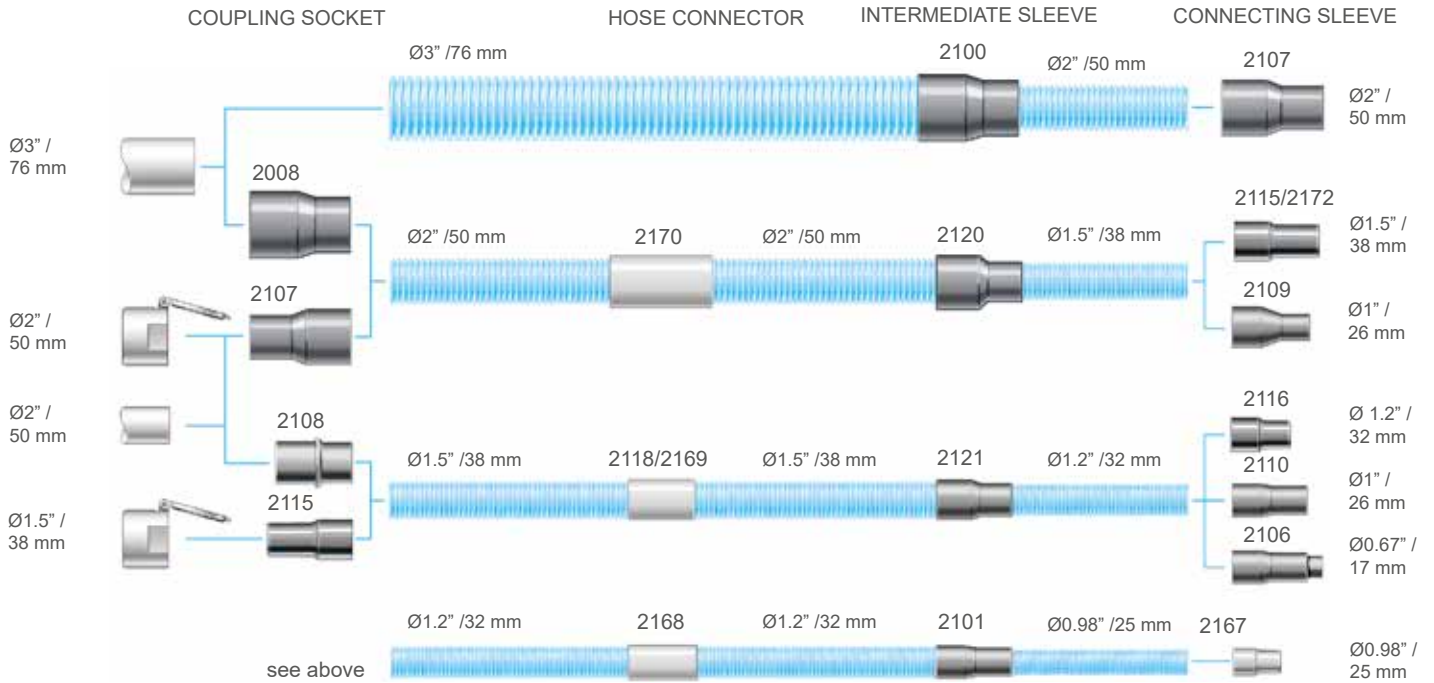

Part No	Description
2008*	Coupling sleeve Ø3"/2" /76/50
2100*	Intermediate sleeve Ø3"/2" /76/50
2101*	Intermediate sleeve Ø1.2"/0.98" /32/25
2106*	Connecting sleeve Ø0.67"/1.2" /17/32
2107*	Coupling sleeve Ø2"/2" /50/50
2108*	Coupling sleeve Ø2"/1.5" /50/38
2109*	Connecting sleeve Ø1"/1.5" /26/38

Part No	Description
2115	Connecting sleeve Ø1.2"/1.2" /32/32
2116	Connecting sleeve Ø1.2"/1.2" /32/32
2118	Connecting sleeve Ø1.2"/1.2" /32/32
2120*	Intermediate sleeve Ø2"/1.5" /50/38
2121*	Intermediate sleeve Ø1.5"/1.2" /38/32
2156*	Coupling Nipple 75/72.5. 2156 is used to connect the 76 mm hose to flap valve, 76/76 art. 3237

Part No	Description
2167*	Connecting sleeve Ø0.98"/0.98" /25/25
2168*	Hose connector Ø1.2" /32
2169*	Hose connector Ø1.5" /38
2170*	Hose connector Ø2" /50



*To order an antistatic (ESD) version, add E to the end of Part No.

Camlock Retrofit Kit

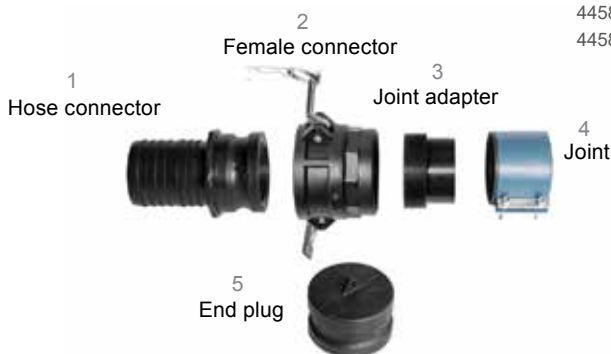

Part No	Description
44585	CAMLOCK KIT 3" PP
44585-1	CAMLOCK KIT 3" AL
44585-2	CAMLOCK KIT 2" PP
44585-3	CAMLOCK KIT 2" AL
44585-4	CAMLOCK KIT 4" PP
44585-5	CAM LOCK KIT 4" AL



Accessories and Consumables

Hoses Sets

Part No

2125	Hose set Ø50/38 L = 7 m Ø2"/1.5" L = 23 ft
2126	Hose set Ø 50/38 L = 7 m Ø2"/1.5" L = 23 ft antistatic
2006	Hose set Ø 38 L = 2 m Ø1.5" L = 6.5 ft
2015	Hose set Ø38/1.5" L = 2 m/6,5ft
2105	Hose set Ø38/1.5" L = 5 m/16ft**

** Standard suction hose, turnable, non removable connector.(Replacement to standard hose kit)

Standard suction hose, turnable
intermediate sleeve 50/38

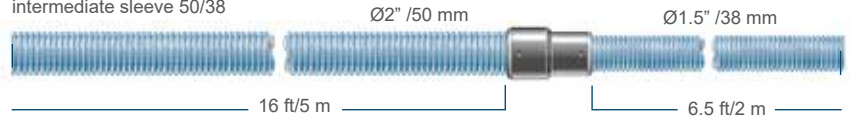

Antistatic suction hose, turnable
intermediate sleeve 50/38

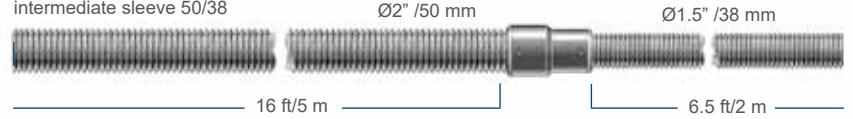

Standard suction hose, turnable
intermediate sleeve 50/38

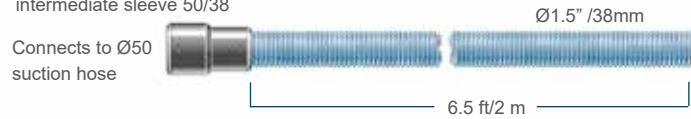

Standard suction hose, turnable
intermediate sleeve 50/38

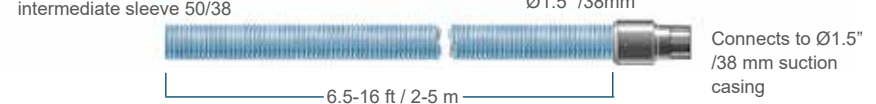

Characteristics of Materials

DESCRIPTION	Dimension Ø [mm/in]	Part No	Colour	Material	Temp °F max/min/ Temp °C max/min	Antistatic	Abrasion resistance	UV and zone resistance	Resistance to welding fume	Resistance to solvent and oil
Coupling socket	76/50 /3/2	2008*	Black	EPDM	284/-76/140/-60	Yes	2	1	2	4
	50/50 /2/2	2107*	Black	EPDM	284/-76/140/-60	Yes	2	1	2	4
	50/38 /2/1.5	2108*	Black	EPDM	284/-76/140/-60	Yes	2	1	2	4
	76/50 /3/2 (PU)**	2161*	Black	EPDM	284/-76/140/-60	Yes	2	1	2	4
Coupling socket	76/50 /3/2	2162*	Blue	NBR	248/-76/120/-60	Yes	2	3	3	2
Coupling sleeve	50/50 /2/2	2129*	Black	PA12	284/-4/140/-20	Yes	1	2	3	1
	50/50 /2/2 (PU)**	2158*	Black	PA12	284/-4/140/-20	Yes	1	2	3	1
	50/38 /2/1.5 (PU)**	2157*	Black	PA12	284/-4/140/-20	Yes	1	2	3	1
	50/38 /2/1.5	2128*	Black	PA12	284/-4/140/-20	Yes	1	2	3	1
Connecting sleeve	38/32 /1.5/1.25	2133*	Black	PA12	284/-4/140/-20	Yes	1	2	3	1
	32/32 /1.25/1.25	2171*	Black	PA12	284/-4/140/-20	Yes	1	2	3	1
	38/38 /1.5/1.5 (PU)**	2159*	Black	PA12	284/-4/140/-20	Yes	1	2	3	1
	38/38 /1.5/1.5	2114*	Black	PA12	284/-4/140/-20	Yes	1	2	3	1
Connecting sleeve	50/50 /2/2	2129*	Black	PA12	284/-4/140/-20	Yes	1	2	3	1
	25/25 /1/1	2167*	Black	TPE	284/-4/140/-20	Yes	1	2	3	1
	38/38 /1.5/1.5	2115*	Black	TPE	284/-4/140/-20	Yes	1	2	3	1
	26/38 /1/1.5	2109*	Black	EPDM	284/-76/140/-60	Yes	2	1	2	4
Connecting sleeve	26/32 /1/1.25	2110*	Black	EPDM	284/-76/140/-60	Yes	2	1	2	4
	17/32 /0.7/1.25	2106*	Black	EPDM	284/-76/140/-60	Yes	2	1	2	4
	32/32 /1.25/1.25	2116	Grey	PE	45/-45	No	1	2	3	1
Inter, sleeves	25/25 /1/1	2117	Grey	PE	45/-45	No	1	2	3	1
	50/38 /2/1.5	2131*	Black	PA12	284/-4/140/-20	Yes	1	2	3	1
Inter, sleeves	50/38 /2/1.5 (PU)**	2160*	Black	PA12	284/-4/140/-20	Yes	1	2	3	1
	76/50 /3/2	2100*	Black	EPDM	284/-76/140/-60	Yes	2	1	2	4
	50/38 /2/1.5	2120*	Black	EPDM	284/-76/140/-60	Yes	2	1	2	4
	38/32 /1.5/1.25	2121*	Black	EPDM	284/-76/140/-60	Yes	2	1	2	4
Hose connector	32/25 /1.25/1	2101*	Black	EPDM	284/-76/140/-60	Yes	2	1	2	4
	50/2	2403	Grey	PE	45/-45	No	2	2	3	3
	38/1.5	2118	Grey	PE	45/-45	No	2	2	3	3
	32/1.25	2119	Grey	PE	45/-45	No	2	2	3	3
Hose connector	50/2	2170*	Black	EPDM	284/-4/140/-20	Yes	1	2	3	1
	38/1.5	2169*	Black	EPDM	284/-4/140/-20	Yes	1	2	3	1
	32/1.25	2168*	Black	EPDM	284/-4/140/-20	Yes	1	2	3	1

* Antistatic is defined as having a conductivity of < 10⁹ Ω
To order an antistatic ESD version, add the letter E to the end of the part No.
** The wire helix must be bared and left in contact with conductive material

Resistance Scale

- 1 Excellent
- 2 Good
- 3 Limited
- 4 Poor



Accessories and Consumables

Cleaning accessories $\varnothing 38 \text{ mm} / 1.5''$

DC Reach – High Level Cleaning System

With our innovative cleaning technology DC Reach, it has never been easier to remove dust and combustible materials from high altitudes and hard-to-reach places. Traditionally, cleaning at height has involved hydraulic lifting aids, work platforms and at least two people to carry out the job safely. Now the task can be solved safely by one person.

The system consists of a pipe system with straight pipe parts and bends that are connected as desired. Along with this, there are several suction nozzles to meet the customer's unique needs.

In addition to the standard version of DC Reach, there is also DC Reach ATEX for customers who need equipment suitable for an ATEX environment. All these components are certified and meet the ATEX-directive 2014/34/EU: ISO 80079-36:2016, ISO 80079-37 and are NFPA certified.

Part No DC Reach System

7600	DC Reach Standard
7620	DC Reach ATEX



Standard Set

7601	Pipe, Carbon fiber, L - 1.25m x $\varnothing 38\text{mm}$
7602	Bend 135 degrees
7603	Bend 90 degrees
7604	Bend 45 degrees
7605	Adaptor for Nozzle
7606	Adaptor for Hose
7607	Nozzle, W200mm
7608	Nozzle, W380mm
7609	Floor Nozzle, W300mm
7611	Bag for Pipes
7613	Bag for Accessories
7615	Nozzle, round
7616	Nozzle, elonged, W200

DC Reach Standard Set Prod No 7600



ATEX Set

7621	6 x ATEX Pipes, Carbon fiber, L - 1.25m x $\varnothing 38\text{mm}$
7622	ATEX Floor Nozzle, W200mm
7623	ATEX Flat Nozzle
7624	ATEX Nozzle, W200mm
7626	ATEX Adaptor for Hose
7627	ATEX Bend 135 degrees
7628	ATEX Bend 90 degrees
7629	ATEX Bend 45 degrees
7630	ATEX Nozzle, straight
7611	Bag for Pipes
7613	Bag for Accessories

DC Reach ATEX Set Prod No 7620



Suction Casings



Finding the right suction casing

Machine		Make			Type	
D	d	H	h	A	B	M

Legend

- F Fibre disc
- D Diamond cup grinding disc
- N Depressed centre disc
- K Abrasive disc, diamond disc
- S Abrasive cup stone

If you cannot find the suction casing you are looking for, contact your sales representative for pricing information regarding a product tailored to your specific needs.

F
Fibre Disc

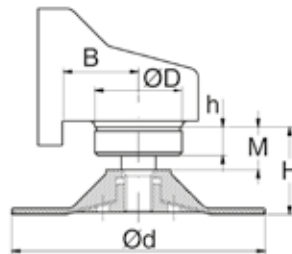

D
Diamond Cup Grinding Disc

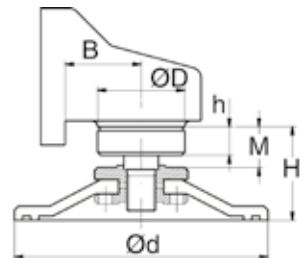

N, K
Depressed Centre Disc,
Abrasive Disc, Diamond Disc

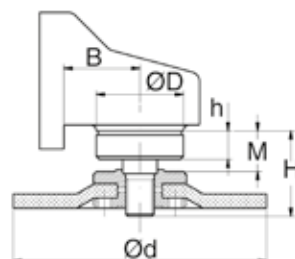

S
Abrasive Cup Stone

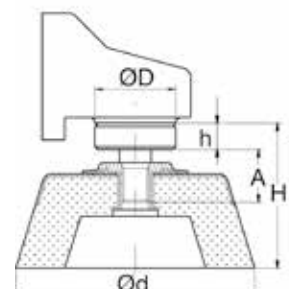

Suction Casings Suction Casing Kit for Fibre Discs (F)

1

Measure the diameter of the disc.



2

Measure the diameter of the mounting collar on the machine - ØD and the height of the machine - H.

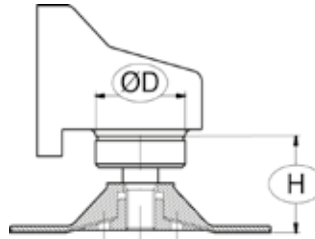

3

Check out our range of Suction Cases to fit your need. Mount the Suction Casing and ready to use!



Technical data

DISC DIAMETER	Ø D [mm/in]	H [mm/in]	Connection, Ø [mm/in]	Part No
1½–3" (38–75 mm)	27 /1.1	*	32 /1.25	6833*
4" (100 mm)	40–49 /1.6–1.9	39–44 /1.5–1.7	32 /1.25	6670
4½" (115 mm)	40–49 /1.6–1.9	39–48 /1.5–1.9	32 /1.25	6671
5" (125 mm)	40–49 /1.6–1.9	39–48 /1.5–1.9	32 /1.25	6672
5" (125 mm)	50/2	38–61 /1.5–2.1	32 /1.25	6673
7" (175 mm)	54–61 /2.1–2.4	50–59 /2–2.3	38 /1.5	6674

** Some Hitachi machines have a Ø40 mm /1.6" conical neck. With these, it is necessary to buy an aluminium ring (Part No. 6270). When fitted on the machine, this aluminium ring enlarges the ØD of the machine to 50 mm /1.9" – therefore choose the 5" N, K suction casing kit – Part No. 6678.



Accessories and Consumables

Suction Casings Suction Casing Kit for Diamond Cup Grinding Discs (D)

1

Measure the diameter of the disc.



2

Measure the diameter of the mounting collar on the machine - $\varnothing D$ and the height of the machine - H.

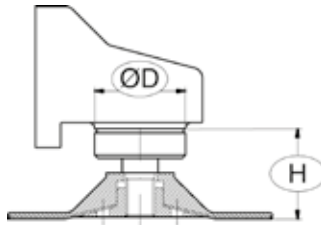

3

Check out our range of Suction Cases to fit your need. Mount the Suction Casing and ready to use!



Technical data

DISC DIAMETER	$\varnothing D$ [mm/in]	H [mm/in]	Connection, \varnothing [mm/in]	Part No
4½" (115 mm)	40–49 / 1.6–1.9	49–54 / 1.9–2.1	32 / 1.25	6681
5" (125 mm)	40–49 / 1.6–1.9	49–70 / 1.9–2.8	32 / 1.25	6682
5" (125 mm)	50/2	38–61 / 1.5–2.4	32 / 1.25	6673
7" (175 mm)	54–61 / 2.1–2.4	63–72 / 2.5–2.8	38 / 1.5	6683
7" (175 mm)	62–65 & 74–77 / 2.4–2.6 & 2.9–3	63–86 / 2.5–3.4	38 / 1.5	6684



Accessories and Consumables

Suction Casings

Suction Casing Kit for Depressed Centre Discs, Abrasive Discs and Diamond Discs (N, K)

1

Measure the diameter of the disc.



Note: Max. thickness of disc = 18 mm.

2

Measure the diameter of the mounting collar on the machine $\varnothing D$ and the height of the machine - H.

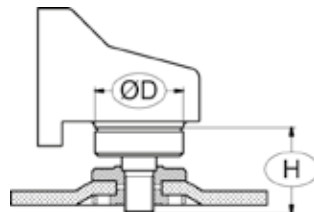

3

Check out our range of Suction Cases to fit your need. Mount the Suction Casing and ready to use!



Technical data

DISC DIAMETER	$\varnothing D$ [mm/in]	H [mm/in]	Connection, \varnothing [mm/in]	Part No
4 ½" (115 mm)	40–49 /1.6–1.9	31–46 /1.2–1.8	32 /1.25	6676
5" (125 mm)	40–45 /1.6–1.8	31–46 /1.2–1.8	32 /1.25	6677**
5" (125 mm)	46–53 /1.8–2.1	31–46 /1.2–1.8	32 /1.25	6678
9"*	112 /4.4	37 /1.5	38 /1.5	6221*
9"	68 /2.7	51 /2	38 /1.5	6202*
9"	74 /2.9	54 /2.1	38 /1.5	6302*
9"	74 /2.9	37 /1.5	38 /1.5	6349*
9"	50 /2	47 /1.9	38 /1.5	6500*
9"	62 /2.4	54 /2.1	38 /1.5	6416*
9"	62 /2.4	50 /2	38 /1.5	6438*
9"	62 /2.4	48 /1.9	38 /1.5	6555*
9"	65 /2.6	40 /1.6	38 /1.5	6842*
9"	64 /2.5	52 /2	38 /1.5	6427*
9"	58 /2.3	54 /2.1	38 /1.5	6537*
9" Georges Renault KL 365		59 /2.3	38 /1.5	6388*

* With the clamping rings welded on the suction casings.

** Some Hitachi machines have a $\varnothing 40$ mm conical neck. With these, it is necessary to buy an aluminium ring (part no 6270). When fitted on the machine, this aluminium ring enlarges the $\varnothing D$ of the machine to 50 mm – therefore choose the 5" N, K suction casing kit – Part No 6678.

Connection \varnothing

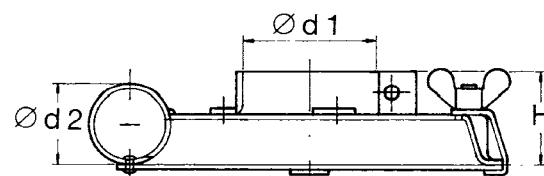

Suction Casings

Suction Casing for Hammer Drills, Chisels and Breakers



Suction casings B, H, M, L

No	Part No	Connection tool Ø [mm/in]	Hose connection Ø [mm/in]	Height [mm/in]
1	6621	48 /1.89	38 /1.5	158 /6.22
2	6622	43 /1.69	38 /1.5	158 /6.22
3	6077	32 /1.26	32 /1.26	112 /4.4
4	6078	61 /2.4	38 /1.5	178 /7
5	6001 (handpipe)	-	50 /2	100 /3.9
6	6130	Bellow for 6078, 6621 and 6622		

Part No 6622 and 6077 are suitable for small chisel hammers.

Model-specific suction casings

Part No	Model	Hose connection Ø [mm/in]
6229	Atlas Copco RRD 37/RRD 57	38 /1.5
6152	Atlas Copco BBD 11/RRC 73	38 /1.5

Accessories and Consumables

Suction Casings Spare Parts for Suction Casings

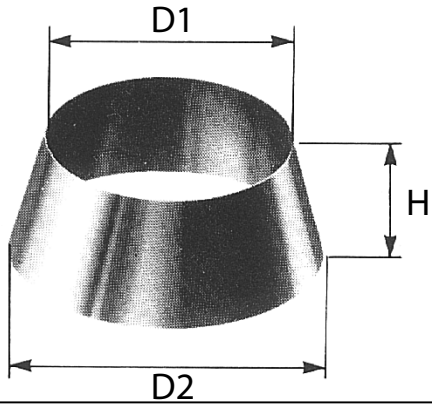

Description		Dimension			Part No
		D1 [mm/in]	D2 [mm/in]	H [mm/in]	
Plastic ring for saucer grinder	5 S	121 /4.8	139 /5.5	50 /2	6003
	6 S	147 /5.8	164 /6.5	50 /2	6004
Rubber collar for fibre disc (F)	1 ½ F	39 /1.5	59 /2.3	23 /0.9	6314
	2 F	39 /1.5	69 /2.7	23 /0.9	6313
	3 F	39 /1.5	95 /3.7	25 /1	6312
	4 F	72 /2.8	117 /4.6	13 /0.5	6182
	4 ½ F	72 /2.8	135 /5.3	13 /0.5	6181
	4 ½ F	72 /2.8	135 /5.3	23 /0.9	618100
5 F	72 /2.8	145 /5.7	13 /0.5	6195	
Rubber collar for fibre disc (F)	5 F	96 /3.8	150 /5.9	15 /0.6	6006
Rubber collar for oscillating sanding machine	5 O	72 /2.8	145 /5.7	38 /1.5	6212
	6 O	96 /3.8	170 /6.7	28 /1.1	6180
Rubber collar for fibre disc (F)	7 F	112 /4.4	196 /7.7	19 /7	6002
	7 F	112 /4.4	196 /7.7	35 /1.4	6034
	8 F	112 /4.4	221 /8.7	41 /1.6	6211
	9 F	113 /4.5	250 /10	32 /1.25	6039

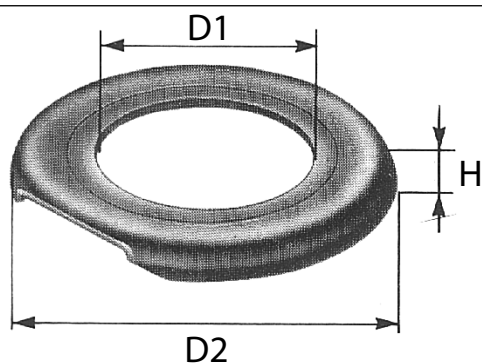
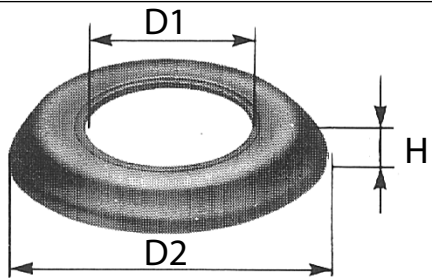
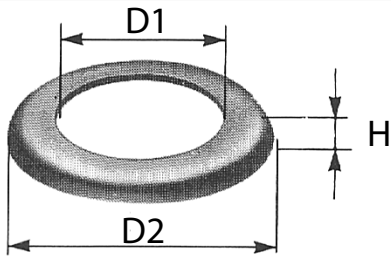
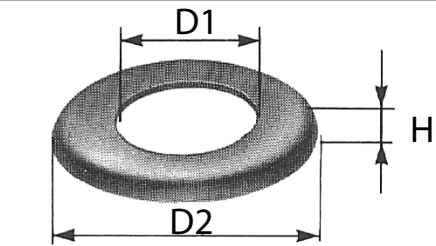

Select the right bag for your machine.

46145



42702



43619



42384



42111



42951



42285



42190



42291



4714



4314



44077 ^o 25 m /82 ft

432177 ^o 23 m /75 ft

45379 ^o XXX-Strong 20 m /65 ft

44763 ^o 12 m /39 ft



Plastic Bags

Accessories and Consumables

MODEL	Standard Bag [Prod No]	Antistatic/ESD	Volume [l/gal]	Size Standard bag WxH [mm/in]
DC 1800	42291 ^A	42951 ^D	30/7.9	350x200x550 / 13.8x7.9x21.7
DC 1800 XL	42285 ^D	42384 ^D	60/15.5	360x700 / 14x27.5
DC 2900 c	42702 ^A	-	31/7.9	280x180x800 / 11x7.1x31.5x34.2 + 23 m / 75 ft
DC 2900 L	44763 ^B + 432177 ^B Longopac	-	20/5	12 m / 39 ft + 23 m / 75 ft
DC 1800 H Asbestos	42285 ^D	42384 ^D	20/5	360x700 / 14x27.5
DC 2800 H Asbestos	42285 ^D	42384 ^D	70/15.4	360x700 / 14x27.5
DC Tromb 400 c	43619 ^A	42384 ^D	33/7.3	500x850 / 19.7x33.5
DC Tromb 400 a	42285 ^G	42384 ^D	70/15.4	360x700 / 14x27.5
DC Tromb 400 L	432177 ^B Longopac	-	-	23 m / 75 ft
DC Tromb Turbo Direct c	43619 ^A	42384 ^D	33/7.3	280x170x870 / 11x6.7x34.3
DC Tromb Turbo Direct L	432177 ^B Longopac	-	-	23 m / 75 ft
DC Tromb Turbo VFD c	43619 ^A	42384 ^D	33/7.3	280x170x870 / 11x6.7x34.3
DC Tromb Turbo VFD L	432177 ^B Longopac	-	-	23 m / 75 ft
DC Tromb Twin aa	42285 ^G	42384 ^D	70/15.4	360x700 / 14x27.5
DC Tromb Twin cc	43619 ^A	42384 ^D	33/7.3	280x170x870 / 11x6.7x34.3
DC Tromb Twin cL	43619 ^A + 432177 ^B Longopac	42384 ^D	33/7.3	280x170x870 / 11x6.7x34.3 + 23 m / 75 ft
DC Tromb Twin LL	432177 ^B Longopac	-	-	23 m / 75 ft
DC Tromb 400 H Asbestos	42285 ^G	42384 ^D	70/15.4	360x700 / 14x27.5
DC Chip Extractor	4714 ^C	-	90/23	700x1100 / 27.5x43.3
DC 4000 PCB	42285 ^D	42384 ^D	70/15.4	360x700 / 14x27.5
DC 5900 c	46145 ^A	-	60/15.9	420x220x1000 / 16.5x8.7x39.4
DC 5900 L	44077 ^D Longopac + 44248 ^E	-	-	25 m / 82 ft
DC 5900 H Asbestos	46141 ^D	-	75/19.8	700x1100 / 27.5x43.3
DC Storm c	46145 ^A	-	60/15.5	640x1000 / 25.2x39.4
DC Storm LPG	44077 ^D Longopac	-	-	25 m / 82 ft
S 11000	4714 ^C	42111 ^C	100/26.4	700x1100 / 27.5x43.3
S 11000	44078 ^D Holder	42111 ^C	90/23	700x1100 / 27.5x43.3
S 2100/32000/34000/34000X	4714 ^C	42111 ^C	100/26.4	700x1100 / 27.5x43.3
DC 50W /DC 75W	42190 ^D	-	-	-
DCF Storm c	46145 ^A	-	60/15.5	640x1000 / 25.2x39.4
DCF Storm L	44077 ^D Longopac	-	-	25 m / 82 ft
DCF 2900 c	42702 ^A	-	20/5	440x550 / 17x 21.7
DCF 2900 L	44763 ^B	-	40/10	12 m / 39 ft
DCF Tromb c / DCF Tromb a	43619 ^A / 42285 ^G	-	33/7.3	280x170x870 / 11x6.7x34.3
DCF Tromb L	432177 ^B Longopac	-	-	23 m / 75 ft
DCF Mobile	4714 ^C	42111 ^C	100/26.4	700x1100 / 27.5x43.3
F 20000	4714 ^C	42111 ^C	100/26.4	700x1100 / 27.5x43.3
F 30000	4714 ^C	42111 ^C	100/26.4	700x1100 / 27.5x43.3
DC 1800/2800 EX	-	42951 ^F	40/8.8	360x400 / 14x15.7
DC Tromb Turbo EX	-	42385 ^G	175/38.5	360x700 / 14x27.5
DC 5800 Turbo EX	-	42111 ^C	175/38.5	450x1100 / 17.7x43.3
DC 1800 TR EX	-	42384 ^F	70/15.4	360x700 / 14x27.5
DC 2800 TR EX	42285 ^D	42384 ^D	70/15.4	360x700 / 14x27.5
DC 3800 Turbo TR EX	-	42384 ^F	70/15.4	360x700 / 14x27.5
DC 5900 Turbo TR	46145 ^A	-	60/15.5	640x1000 / 25.2x39.4

A Set of 10 bags
B Set of 4 bags
C Set of 50 bags

D Individual bags
E Adaption Kit for Longopac
F Set of 25 bags

G Set of 5 bags



Bag strap (Part No)
4313, 1 m 4613, 1.5 m

Choose the Right Filter

Pleated design increases the filtering surface. For filtering to be effective without affecting user performance, the air velocity through the filter must be maintained but without overloading the volume capacity of the filter media. Suitable filter loadings vary with the material being extracted. Suitable filter loading, measured in m^3/hr per m^2 of filter area, for concrete dust is for example, a maximum of $120\text{m}^3/\text{hr}$ per m^2 , while welding fume is only $60\text{m}^3/\text{hr}$ per m^2 as it exerts a higher filter loading or simply put, it will block the filters more quickly. This is always considered in Dustcontrol's design criteria.

Our dust extractor separates dust in three stages:

1. Large particles are separated dynamically in the **Cyclone**.
2. Filtration then takes place in the pleated **Fine Filter**.
3. Followed by a pleated **Microfilter** HEPA H13.

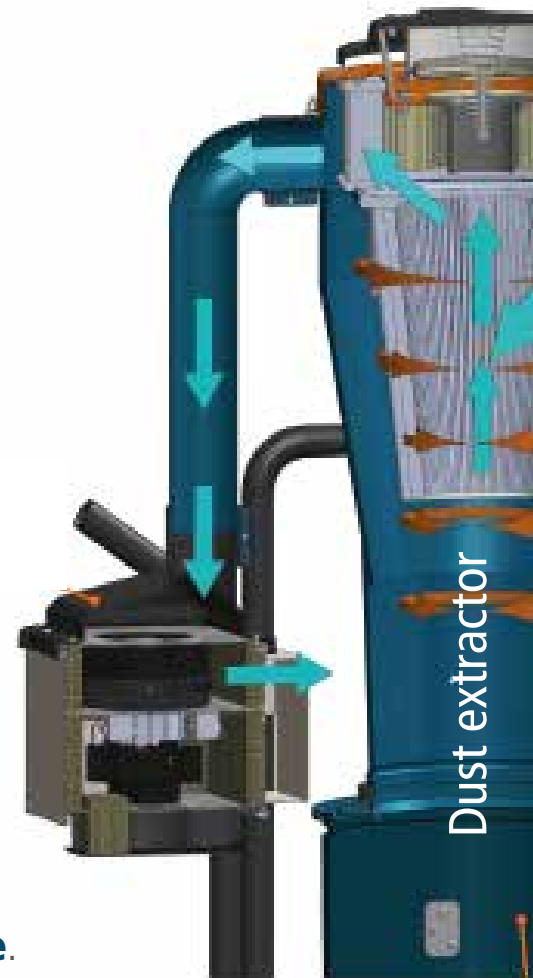

The Fine Filter. This filter is designed to capture the small particles that are not captured in the pre-separator or cyclone.



Cellulose Fine Filter

A high-quality, standard filter with high filtration efficiency. Epoxy-treated for improved resistance to humidity and other elements. It is pleated around a support cylinder.

Polyester Fine Filter

A high-quality filter resistant to most substances. Perfect for use in wet environments such as mechanical workshops in which cutting fluids etc. is used. Slightly smoother surface than the cellulose filter, enabling more efficient cleaning and a longer service life. The filter is washable.

PTFE Fine Filter

The polyester filter is treated with PTFE, meaning that the filter coating can easily be separated from the surface. This type of filter is suitable for use in applications such as floor grinding. The filter is washable.

A Pre-Filter is a basic filter used with air

cleaners in order to capture large particles and relieve the loading on the HEPA filter. The pre-filter is designed as a pleated filter in cassette or textile form. It is disposable. Each Pre-Filter filter is individually tested for level G4 compliance.

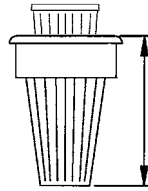
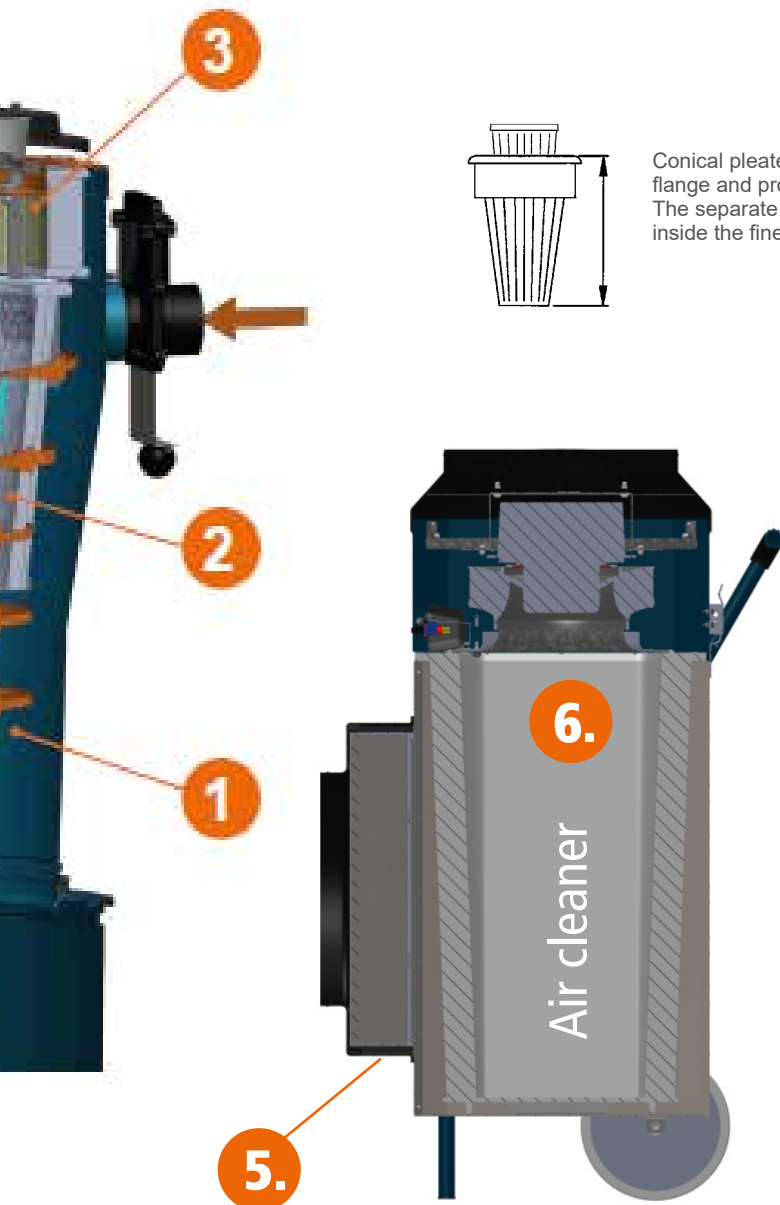

Conical pleated filter with sealing flange and protective jacket. The separate HEPA filter is fitted inside the fine filter.



Air cleaner

Our Air cleaners separate dust in two stages:

4. Large particles are separated by the **Carpet Pre-filter**, or a
5. **Pre-filter cartridge**,
6. followed by a pleated **HEPA H13 Microfilter**

Microfilter, HEPA filter, Absolute Filter goes by many names, and has a filtration efficiency of 99.995%.



A HEPA Filter

The HEPA filter is assembled from a very fine-meshed fibreglass textile with extremely deep-acting properties. One or two layers of e.g. cellulose may be added to improve rigidity.

Each HEPA filter is individually tested for level H13 compliance. The test report can be obtained on request.

Dustcontrol's HEPA filters comply with the requirements for H-class dust extractors. The HEPA filter should be replaced when it becomes saturated.

All Dustcontrol's dust extractors and air cleaners, have a separate HEPA H13 filter installed after the fine filter or pre-filter. The filter systems in all Dustcontrol dust extractors are built to comply with the the stringent IEC machine classification H.



Filters

DC 1800/2900, DC 1800/2800 EX, DC 1800/2800 TR EX, DC 1800/2800 Asbestos

Part No	Type of filter / Machine	Construction	Material	Area [m ² /ft ²]	Classification	Max temp
42029	Fine filter, DC 1800/2900cL	Pleated around support cylinder	Cellulose, epoxy-treated	1.5 /16.2	IEC EN 60335-2-69 Part 1	176°F /80°C
42029ST	Fine filter x 48	Pleated around support cylinder	Cellulose	1.5 /16.2	IEC EN 60335-2-69 Part 1	176°F /80°C
42028	Fine filter, DC 1800/2900a, DC 1800/2800 Asbestos	Pleated	Polyester	1.5 /16.2	IEC EN 60335-2-69 Part 1	266°F /130°C
42028-01	Fine filter, DC 1800/2900, 1800/2800 TR EX DC 1800/2800 EX	Pleated	Polyester, antistatic	1.5 /16.2	IEC EN 60335-2-69 Part 1	266°F /130°C
42028-02	Fine filter, PTFE DC 1800/2900	Pleated	Polyester, PTFE	1.5 /16.2	IEC EN 60335-2-69 Del1	100 °C
42027	HEPA filter, DC 1800/2900, DC 1800/2800 EX, DC 1800/2800 TR EX, DC 1800/2800 Asbestos	Pleated	Cellulose, fibreglass	0.85 /9.1	HEPA H13 EN 1822-1	176°F /80°C

DC Tromb, DC Tromb Twin, DC Tromb Turbo, DC Tromb Turbo Twin, DC Tromb Turbo EX, DC Tromb Asbestos, DC Tromb Turbo VFD Asbestos, DC Chip Extractor, DC Tromb Stationary

Part No	Type of filter / Machine	Construction	Material	Area [m ² /ft ²]	Classification	Max temp
44017	Fine filter, DC Tromb/Turbo/Twin, DC Turbo E, DC Tromb Turbo VFD Asbestos, DC Chip Extractor, Tromb Stat.	Pleated around support cylinder	Polyester	1.85 /20	IEC EN 60335-2-69 Part 1	176°F/80°C
44017-1	Fine filter, DC Tromb Turbo EX	See above	Polyester, antistatic	1.85 /20	IEC EN 60335-2-69 Part 1	176°F/80°C
44043	Fine filter	Pleated around support cylinder	Cellulose, epoxy-treated	1.85 /20	IEC EN 60335-2-69 Part 1	176°F/80°C
44213	Fine filter, PTFE	Pleated around support cylinder	Polyester, PTFE	2.5 /30	IEC EN 60335-2-69 Part 1	266°F /130°C
44016	HEPA filter, DC Tromb/Turbo/Twin, DC Turbo EX, DC Tromb Turbo VFD Asbestos, DC Chip Extractor	Pleated	Cellulose, fibreglass	2.2 /23.7	HEPA H13 EN 1822-1	176°F/80°C
44016-1	HEPA filter, DC Tromb 600	Pleated	Cellulose, fibreglass	3.3 /35.6	HEPA H13 EN 1822-1	176°F/80°C
44017-2	Fine filter, DC Tromb 600	Pleated around support cylinder	Polyester	2.8 /30.2	IEC EN 60335-2-69 Part 1	176°F/80°C

DC 3800 I, DC 3800 TR EX, DC 4000 PCB

Part No	Type of filter / Machine	Construction	Material	Area [m ² /ft ²]	Classification	Max temp
42025	Fine filter, DC 3800 I, DC 4000 PCB	Pleated	Polyester	1.8 /19.4	IEC EN 60335-2-69 Part 1	266°F /130°C
42025ST	Fine filter x 24	Pleated	Polyester	1.8 /19.4	IEC EN 60335-2-69 Part 1	266°F /130°C
4202501	Fine filter, DC 3800 TR EX	Pleated	Polyester, antistatic	1.5 /16.2	IEC EN 60335-2-69 Part 1	176°F /80°C
42024	HEPA filter, DC 3800 TR EX, DC 4000 PCB	Pleated	Cellulose, fibreglass	1.5 /16.2	HEPA H13 EN 1822-1	266°F /130°C

DC 5800 Turbo Ex, DC 5900, DC 5900 Asbestos, DC 5900 TR, DC Storm 500/600/700

Part No	Type of filter / Machine	Construction	Material	Area [m ² /ft ²]	Classification	Max temp
429203	Fine filter, PTFE, DC 5900	Pleated around support cylinder	Polyester, PTFE	5.0 /53.8	IEC EN 60335-2-69 Part 1	266°F /130°C
44081	Fine filter, PTFE, DC Storm 600/700L	Pleated around support cylinder	Polyester, PTFE	5.0 /53.8	IEC EN 60335-2-69 Part 1	266°F /130°C
429204	Fine filter, DC 5900c 9.2 kW S, DC 5900 Asbestos 4 kW, DC 5900 TR	Pleated around support cylinder	Polyester	5.0 /53.8	IEC EN 60335-2-69 Part 1	266°F /130°C
44212	Fine filter, DC Storm 500acL, DC Storm 600/700ac	Pleated around support cylinder	Polyester	5.0 /53.8	IEC EN 60335-2-69 Part 1	266°F /130°C
4292	Fine filter, DC 5900c 9.2 kW P, DC 5900c Asbestos 9.2 kW P	Pleated around support cylinder	Polyester	8.4 /90.4	IEC EN 60335-2-69 Part 1	266°F /130°C
429206	Fine filter, DC 5800 Turbo Ex	Pleated around support cylinder	Polyester	8.4 /90.4	IEC EN 60335-2-69 Part 1	266°F /130°C
42869	HEPA filter, DC 5800 Turbo Ex, DC 5900 4/9.2 kW S, DC 5900 Asbestos 4 kW (installed under top cover), DC 5900 TR, DC Storm 500acL	Pleated around support cylinder	Cellulose, fibreglass	2.7 /29	HEPA H13 EN 1822-1	176°F /80°C
42807	HEPA filter, DC Storm 600L, DC 5900c 9.2 kW S/P, DC 5900c Asbestos 9.2 kW P	Pleated around support cylinder	Cellulose, fibreglass	3.7 /39.8	HEPA H13 EN 1822-1	176°F /80°C

DC AirCube

Part No	Type of filter / Machine	Construction	Material	Area [m ² /ft ²]	Classification	Max temp
42690	Pre-filter, AirCube 500	Pleated carpet	Polyester	0.18 /1.9	G4	176°F /80°C
42692	HEPA filter, AirCube 500	Pleated	Cellulose, fibreglass	4.56 /49	HEPA H13 EN 1822-1	176°F /80°C
42918	Pre-filter, AirCube 1200	Cartridge	Polyester	0.4 /4.3	G4	140°F /60°C
42940	HEPA filter, AirCube 1200	Pleated	Cellulose, fibreglass	5 /54	HEPA H13 EN 1822-1	194°F /90°C
42917	Pre-filter, AirCube 2000	Cartridge	Polyester	0.5 /5.4	G4	140°F /60°C
42896	HEPA filter, AirCube 2000	Pleated around support cylinder	Cellulose, fibreglass	10 /107	HEPA H13 EN 1822-1	194°F /90°C



Filters for old models

DC 2500i, DC 2500, DC 2500 Twin

Part No	Description	Construction	Material	Area [m ² /ft ²]	Classification	Max temp
4889	Fine filter	Pleated	Polyester	1.4 /15	IEC EN 60335-2-69 Part 1	266°F /130°C
404901	Fine filter	Pleated around support cylinder	Cellulose	1.5 /16.2	IEC EN 60335-2-69 Part 1	158°F /70°C
4821	HEPA filter K	Pleated	Cellulose, fibreglass	1.5 /16.2	HEPA H13 EN 1822-1	158°F /70°C
4133	HEPA filter (fitted in the fine filter)	Pleated around support cylinder	Cellulose, fibreglass	0.5 /5.4	HEPA H13 EN 1822-1	176°F/80°C

DC 2700c, DC 2700i, DC 2800c, DC 2800c Rental

(Machines from serial number 2527595 can be equipped with HEPA filter (Part No 42027).

Older models should be equipped with a HEPA combi-filter.

Part No	Description	Construction	Material	Area [m ² /ft ²]	Classification	Max temp
4889	Fine filter	Pleated	Polyester	1.4 /15	IEC EN 60335-2-69 Part 1	266°F /130°C
404901	Fine filter	Pleated around support cylinder	Cellulose	1.5 /16.2	IEC EN 60335-2-69 Part 1	158°F /70°C
4821	HEPA filter K	Pleated	Cellulose, fibreglass	1.5 /16.2	HEPA H13 EN 1822-1	158°F /70°C
4133	HEPA filter (fitted in the fine filter)	Pleated around support cylinder	Cellulose, fibreglass	0.5 /5.4	HEPA H13 EN 1822-1	176°F/80°C
40479	Combi-filter (Fine filter + HEPA filter), (GS Asbestos)	Pleated	Cellulose, epoxy-treated	1.5 /16.2	HEPA H13 EN 1822-1	176°F /80°C

Accessories and Consumables

Filters for old models

DC 3500, DC 3500TR, DC 3500 Stationary, DC 5500, DC 5500i

Part No	Description	Construction	Material	Area [m ² /ft ²]	Classification	Max temp
408801	Fine filter	Pleated	Polyester	1.6 /17	IEC EN 60335-2-69 Part 1	176°F/80°C
408803	Fine filter	Pleated	Cellulose	1.6 /17	IEC EN 60335-2-69 Part 1	176°F/80°C
4821	HEPA filter, DC 3500 TR	Pleated	Cellulose, fibreglass	1.5 /16.2	HEPA H13 EN 1822-1	158°F /70°C
4366	HEPA filter, DC 3500 (installed on exhaust)	Pleated around support cylinder	Cellulose, fibreglass	1.2 /12.9	HEPA H13 EN 1822-1	176°F/80°C
4422	HEPA filter, DC 5500 5 kW, 9.2 kW S (installed under top cover)	Pleated around support cylinder	Cellulose, fibreglass	2.5 /26.9	HEPA H13 EN 1822-1	176°F/80°C
4017	HEPA filter, DC 5500 9.2 kW P (installed on exhaust)	Pleated around support cylinder	Cellulose, fibreglass	2.8 /30	HEPA H13 EN 1822-1	176°F/80°C

DC 3500i, DC 5700c, DC 5800 a/c 5 kW, DC 5800 a/c PTFE; DC Storm LPG

Part No	Description	Construction	Material	Area [m ² /ft ²]	Classification	Max temp
4917	Combi-filter DC 3500i (Fine filter + HEPA H13 filter)	Pleated	Cellulose, fibreglass	1.5 /16.2	HEPA H13 EN 1822-1	176°F/80°C
4422	HEPA filter, DC 5700 5 kW, 9.2 kW S (installed under top cover)	Pleated around support cylinder	Cellulose, fibreglass	2.5 /26.9	HEPA H13 EN 1822-1	176°F/80°C
4017	HEPA filter, DC 5700 9.2 kW P (installed on exhaust)	Pleated around support cylinder	Cellulose, fibreglass	2.8 /30	HEPA H13 EN 1822-1	176°F/80°C
42807	HEPA filter, DC Storm LPG,	Pleated around support cylinder	Cellulose, fibreglass	3.7 /39.8	HEPA H13 EN 1822-1	176°F /80°C

DC 380, DC 1500, DC AirCube

Part No	Description	Construction	Material	Area [m ² /ft ²]	Classification	Max temp
4080	Pre-filter, DC 380/DC AirCube	Carpet	Polyester	0.1 /1	IEC EN 60335-2-69 Part 1	212°F/100°C
4669	Pre-filter, DC 1500	Carpet	Polyester	0.3 /3.2	IEC EN 60335-2-69 Part 1	212°F/100°C
42136	HEPA filter, DC AirCube	Pleated HEPA filter box	Fibreglass	5.2 /55.9	EN 1822-1, HEPA H13	176°F/80°C

DC 3700c, DC 3800a/c, DC 3800c Turbo, DC 3800 Turbo EX, DC 3800c Twin
DC 3800 TR S, DC 3800i, DC 3800 Stationary, DC 3900, DC Wood Shavings Extractor

Part No	Description	Construction	Material	Area [m ² /ft ²]	Classification	Max temp
42026	Fine filter, DC 3700c	Pleated around support cylinder	Cellulose, epoxy-treated	1.8 /19.4	IEC EN 60335-2-69 Part 1	176°F/80°C
42026ST	Fine filter x 24	See above	Cellulose	1.8 /19.4	IEC EN 60335-2-69 Part 1	176°F/80°C
42025	Fine filter, DC Wood Shavings Extr.	Pleated	Polyester	1.8 /19.4	IEC EN 60335-2-69 Part 1	176°F/80°C
42025ST	Fine filter x 24	Pleated	Polyester	1.8 /19.4	IEC EN 60335-2-69 Part 1	176°F/80°C
42465	Fine filter, PTFE	Pleated around support cylinder	Polyester, PTFE	1.8 /19.4	IEC EN 60335-2-69 Part 1	176°F/80°C
42024	HEPA filter, DC Wood Shavings Extr., DC 3700c	Pleated	Cellulose, fibreglass	1.5 /16.2	HEPA H13 EN 1822-1	176°F/80°C
4202501	Fine filter	Pleated	Antistatic	1.5 /16.2	IEC EN 60335-2-69 Part 1	176°F/80°C
42398	Fine filter, grounded	Pleated around support cylinder	Polyester	1.8 /19.4	IEC EN 60335-2-69 Part 1	176°F/80°C

Accessories and Consumables

Packaging

Dustcontrol Premium Packaging

Dustcontrol is now offering a more robust premium alternative of packaging to protect and secure the transport of larger mobile and semi-mobile units. Premium packaging is designed for fast, quiet and ergonomic mounting/disassembling with the aid of sheet metal clips and tape sealing.

Premium Packaging is an option when ordering and the prices are set according to the table above. Up on return an undamaged packaging to Dustcontrol AB, half of the packaging cost will be credited.



Part No Description

44637	Premium Packaging for DC 11-Module XL
44638	Premium Packaging for DC 5900 / DC Storm
44639	Premium Packaging for DC Storm
44640	Premium Packaging for DC 11-Module



Dustcontrol

Healthy Business – Healthy Team



Dustcontrol

INVISIBLE

THE HAZARDS ARE WHAT YOU CANNOT SEE

Our mission is to highlight the health concerns and consequences of not using the right equipment. We highlight the dangers – those tiny particles that penetrate deep into the lungs, causing lung cancer, asthma and chronic bronchitis, among other things.

To be a leader in this industry you need a core issue. Ours is health – Technology for Healthy Business. We create products that solve the problems associated with unhealthy working environments and that eliminate the hazards the eye cannot see.

Visit dustcontrol.com to read more about how we can help you with what you cannot see.

www.dustcontrol.com

Contact our Customer Service Department in our Head Office in Norsborg or visit our website for our worldwide distributors for further info, support, service or a demonstration.

Head Office

Dustcontrol AB
Box 3088 • Kumla Gårdsväg 14
145 03 Norsborg, Sweden
Telephone: +46(0)8 531 940 00
support@dustcontrol.se
www.dustcontrol.com

Download our catalogues from Dustcontrol.com



Save time – use QR codes

There are QR codes on all our mobile machines. Scan the code and you will be able to see videos on filter cleaning and how to replace filters and plastic bags.

No QR reader in your smartphone?
Download it from the App/Android store

How to use our QR codes?
See our video on YouTube
<https://www.youtube.com/watch?v=0BSocYF-6MU>

Which solution will you choose?

As a true professional, you have high requirements for your equipment. Dustcontrol has been involved with dust extraction and material transport for more than 50 years and we supply dust extractors and air cleaners for all types of applications. No matter what you choose, you can be sure of getting truly professional equipment that is built with your work environment and health in mind.

Dustcontrol Worldwide



AT

Dustcontrol Ges.m.b.H.
info@dustcontrol.at
www.dustcontrol.at



AU

All Preparation Equipment
www.allpreparationequipment.com.au



BA

TENZO d.o.o.
info@tenzo.ba
www.tenzo.ba



BENELUX

Dust Solutions BV
www.dustsolutions.nl



CA

Dustcontrol Canada Inc.
info@dustcontrol.ca
www.dustcontrol.ca



CH

Rosset Technik
Maschinen Werkzeuge AG
info@rosset-technik.ch
www.rosset-technik.ch



CL

Ambitec S.A.
informaciones@ambitec.cl
www.ambitec.cl



CN

Suzhou Dustcollect Filtration
Technology Co. Ltd.
wang@dustcollect.cn
www.dustcollect.cn



CZ / SK

IML TRADING s. r. o.
info@dustextraction.sk
www.dustextraction.sk



DE

Dustcontrol GmbH
info@dustcontrol.de
www.dustcontrol.de



DK

CONSTRUCTION:
Erenfred Pedersen A/S
info@ep.dk
www.ep.dk

INDUSTRY:
Dansk Procesventilation ApS
info@dansk-procesventilation.dk
www.dansk-procesventilation.dk



EE

G-Color Baltic OÜ
sales@g-color.ee
www.g-color.ee



ES

Barin, s.a.
info@barin.es
www.barin.es



GB

Dustcontrol UK Ltd.
sales@dustcontrol.co.uk
www.dustcontrol.co.uk



GR

Mavrogianakis S.A
ektox@enternet.gr
www.ektoxetine.com.gr



FI

Dustcontrol FIN OY
dc@dustcontrol.fi
www.dustcontrol.fi



FR

CONSTRUCTION:
SMH Equipements
info@abequipements.com
www.smhequipements.com

INDUSTRY:
Dustcontrol AB
info@dustcontrol.fra
www.dustcontrol.fra



HR

Kermek d.o.o.
kruno.nedeljko@kermek.com
www.kermek.com



HU

Vandras Kft
vandras@t-online.hu
www.vandras.hu



IN

Advance Ventilation Pve Ltd.
sales@advanceventilation.com
www.advanceventilation.com



IT

Airum srl
info@airum.com
www.airum.com



KR

ESH Engineering Co.
eshengco@gmail.com
www.eshengco.com



LT

UAB Hidromega
info@hidromega.lt
www.hidromega.lt



LV

SIA Reaktivs
reaktivs@reaktivs.lv
www.reaktivs.lv



MY, ID

Städa Enviroospace Bhd
info@stada.com.my
www.stada.com.my



NO

Teijo Norge A.S
firmapost@teijo.no
www.teijo.no



NZ

Artizan Diamond Tools
enquiry@artizandiamond.co.nz
www.artizandiamond.co.nz



PE

Efixo
contacto@efixo.pe
www.efixo.pe



PH

Sweden Concrete Machines Inc.
peringe@packoskick.se
www.swedenconcretemachines.ph



PL

Bart Sp. z. o.o.
info@bart-vent.pl
www.bart-vent.pl



PT

Metec-Mecano Técnica, Lda.
geral@metec.pt
www.metec.pt



RO

General Contractor Industry SRL
office@gci-grup.ro
www.gci-grup.ro



RS

Enel Alati
eneldoo@eunet.rs
www.eneldoo.rs



SE

Dustcontrol AB
info@dustcontrol.se
www.dustcontrol.com



SG

Städa Enviroospace Pte Ltd
Info@stada.com.my
www.stada.com.my



TH

Vast Metal and Machinery Co., Ltd.
vastmetal@vastmm.com
www.vastmm.com



TR

Ventek Mühendislik Ltd.
info@ventek.com.tr
www.ventek.com.tr



AE

Global Enterprises Trading Co L.L.C.
sales@globalentco.com
www.globalentco.com

GEM
Industrial Equipment Trading Co.
Tel: +971 4 8840 474
Email: gemuae@eim.ae



UA

MBK Obshemashkontrakt, JSC
zao@omk.dp.ua
www.omk.dp.ua



US

Dustcontrol Inc.
info@dustcontrolusa.com
www.dustcontrol.us



VN

Tayhostar JSC
tayhostar@tayhostar.vn
www.tayhostar.vn

Please contact the head office
in Sweden if you do not find a
distributor in your area.
info@dustcontrol.se

Dustcontrol

Strategy and Certifications at Dustcontrol

Dustcontrol operates within the environmental sector. Our products are made to minimise the release of dust, fluids, and other hazardous particles into the environment. Our slogan, "Technology for Healthy Business", is an approach that characterises our entire operation.



We have enlisted the help of the EcoVadis platform to evaluate our sustainability work. Every year, their experts analyze documents that we share from our management system and based on that we get a ranking but also suggestions for future actions.

The four focus areas of Dustcontrols strategy are:



RESPONSIBLE SOURCING
REDUCED ENVIRONMENTAL IMPACT

SUSTAINABLE PRODUCT DEVELOPMENT
ATTRACTIVE WORKPLACE

THE GLOBAL GOALS



Dustcontrol is certified in accordance with ISO 9001, 14001 and 45001 with an integrated quality and environmental management system. This includes process management, identifying our environmental footprint, adhering to regulations, and training our employees in the topic. We carefully adhere to the EU's Reach and RoHS directives in order to minimise our use of chemicals. With the help of Lean production, we continuously evaluate our processes and look to improve our overall efficiency.





Dustcontrol QR Codes

Easily scanned using a smartphone, QR codes work like quick links, taking you straight to the information you need. We aim to make it easy for you to find information about our products, such as how to replace and clean the filter, or replace the bag. Our QR codes make it easy to find helpful instructional videos in the language of your choice, including English, Swedish, German or Finnish.

To scan the codes, you will need to download a QR code reader app. These can be obtained free of charge via the App Store, Android Market or similar platforms.

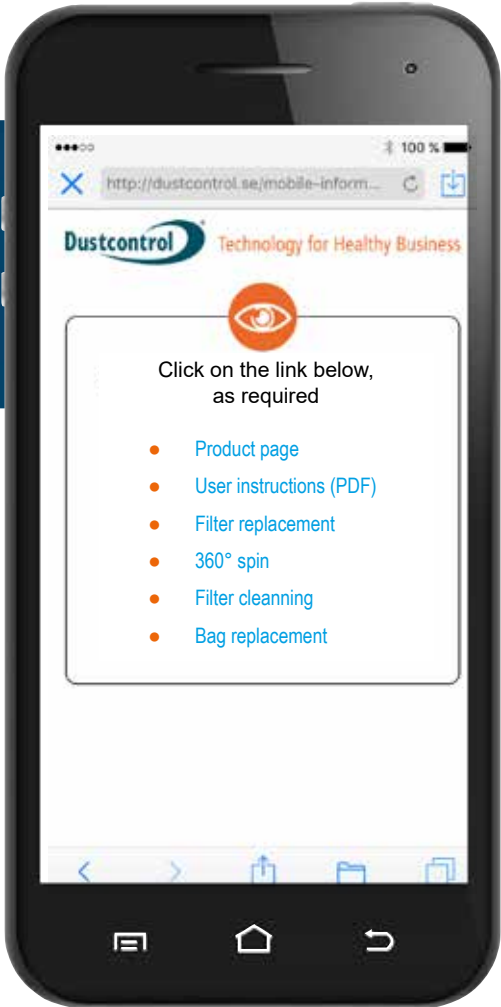

QR codes on our machines & accessories

DC 1800,
DC 2800, DC 2900



DC Tromb



DC 5800, DC 5900,
DC Storm, DC Tromb Turbo



DC AirCube
500 / 1200 / 2000



DC Wet-Vac
50W / 75W



DC Accessories
Food Industry



 **Go to YouTube for a short guidance:**
<https://youtu.be/OBSocYF-6MU>

Dustcontrols Certified Service

Meet our Certified Service Team!

The Dustdoctors at your Service!

We offer a complete service for any of your mobile machines or stationary vacuum systems. If you have a problem with your machine, always contact customer service. In order to get a registration number for your complaint.

Go to www.dustcontrol.com to learn more!

Look out for these Dustdoctors!







Healthy Business

Dustcontrol®

www.dustcontrol.com

Dustcontrol
STORM 600

